

Bell Medical

Anesthesia Products Catalog

XAVANT STIMPOD **NMS 450X** NERVE STIMULATOR

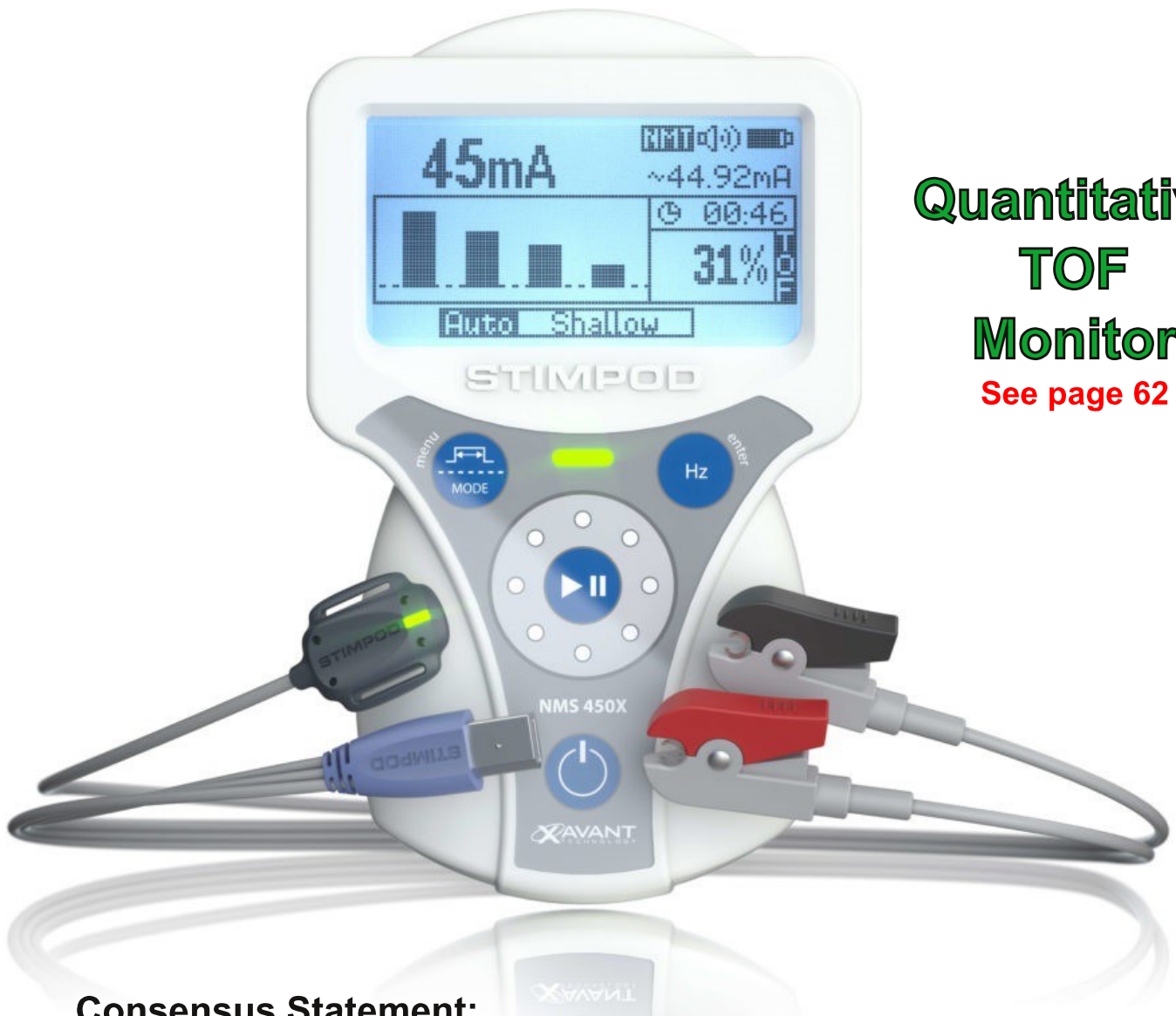

**Quantitative
TOF
Monitor**
See page 62

Consensus Statement:

Subjective peripheral nerve stimulation should be "abandoned" because it is "prone to error". Quantitative TOF is recommended.

BellMedical.com
800-875-BELL (2355)
Volume 7

Insight Airway Management System

See page 31



*The Future is
Bright with
Insight!*

Insight video display fits Flexible Endoscope, Rigid Scope and Video Laryngoscope providing a cost effective ONE SYSTEM solution. Buy the system or order to your needs.

Complete Airway Management System B091990K Includes:

- B091990** Video Laryngoscope, handle
- B091990D** Universal display (2)
- B091998H** Rigid Laryngoscope, handle
- B091999H** Flexible Endoscope, iS3-F 4.0mm, handle
- B091999SH** Flexible Endoscope, iS3-C, iS3 5.8mm scope w/ 2.6mm suction channel, handle

\$19,995

View a video at BellMedical.com/Insight-Airway-Management-System

CUSTOMER INFORMATION

Bell Medical Guarantee!

Minimum 3% savings compared to any competitors catalog pricing.

Phone: 314-772-5600 or 800-875-2355 Monday through Friday, 8:00 AM to 4:45 PM, CST

Email: Email orders to customerservice@bellmedical.com

Fax: 314-772-1233 You may fax your order anytime. Please be sure to include:

- Account number (unless using credit card)
- Billing and shipping address
- Purchase order number, if applicable
- Name, email address and telephone number
- Product number and description
- Unit of measure and quantity ordered

Website: www.BellMedical.com

- Order online. Credit card only at this time.

Prices: Subject to change without notice and do not include shipping and handling.

Terms: Net 10 days from date of invoice.

Minimum: No minimum order. A one time \$6.75 handling charge will be added to all orders.

Payment: Check, AMEX, MasterCard or VISA.

Shipping: All orders are F.O.B. St. Louis, Missouri. All freight charges are prepaid and added to invoice.

Merchandise Returns: All returns must be authorized in advance by Bell Medical, Inc. and be assigned a returned goods authorization number (RGA#) based on the following criteria:

- Merchandise must have been purchased within the last thirty (30) days.
- Merchandise must be in original package and in sellable condition.
- Merchandise returned is subject to a 25% restocking fee unless due to defective product, in which case the merchandise will be replaced, or due to shipping error.
- Merchandise returned due to defect is subject to manufacturer's guidelines.
- There is a minimum restocking charge of \$5.00.

Any credit is subject to final acceptance and inspection of product by Bell Medical, Inc.

The following merchandise is not eligible for return unless proven defective:

- Specially ordered items.
- Used merchandise or products not in original shipping containers.
- Merchandise held over thirty (30) days from shipment.
- Merchandise which has been altered or abused in any way.

Product Warranty: Warranty for products sold will be set by the individual manufacturers of these products. The manufacturer's usual warranty period is one (1) year from date of shipment. The exception to this being rubber, plastic and glass components and materials which are warranted to be free from defects at time of delivery.



Anesthesia Machine and BioMed Service

Bell Medical, Inc. has specialized in anesthesia sales and service since 1975. We are an independent service organization trained by Drager, GE Ohmeda, Penlon, Datascope, and Mindray to service all manufacturers' anesthesia machines. We employ Certified Biomedical Electrical Technicians (CBET's and BMET's) with extensive experience with all anesthesia machines.

We provide comprehensive preventative maintenance for all anesthesia machines regardless of manufacturer. Bell Medical, Inc. uses manufacturer parts for all repairs.

Bell Medical, Inc. offers a comprehensive, fully documented service program, which includes regularly scheduled testing and inspection of the anesthesia machine and related monitors. In addition we provide quarterly Trace Gas Analysis and Room Air Exchange Rate surveys and general biomed service contracts.

Bell Medical, Inc. Service Benefits



Dan Pennington
Service Manager

- Specialist in Anesthesia Machine Service Since 1975
- Service center for Drager, GE, Penlon, Datascope and Mindray
- Over 40 years' Experience Servicing Anesthesia Machines
- Over \$100,000 in Parts Inventory
- Full Products and Completed Service Liability Coverage
- Recondition Anesthesia Machines
- Commitment to Quality Service and Total Customer Satisfaction
- Local Ownership and Commitment to the Community
- One Year Warranty on Parts Replaced
- 90-Day Warranty for All Labor Associated with Repairs

Biomedical Services

Bell Medical offers general biomed services for both surgery centers and clinics as well as on-site full management of biomed service for hospitals. We provide service for specialty devices including sterilizers, scope washers, c-arms, gas monitors, lasers, EKG systems, anesthesia units, ventilators, electrosurgical generators, and much more. We have certified field technicians who can provide on-site repair. We offer superior general biomed services for less than the competition.

To receive a quotation, fax or email a copy of your current contract showing machine models, serial numbers, contract type and expiration date to 314-772-1233 or customerservice@bellmedical.com.

Why Buy New?

Bell Medical, Inc. offers preowned and refurbished Mindray, GE and Drager anesthesia machines. We have machines available for sale with full one year warranty. Bell Medical, Inc. will purchase out dated machines from hospitals and offer trade-in options.

Table of Contents

Bell Medical has a large product selection at www.BellMedical.com.

A		
AIRWAYS, CRICOTHYROTOMY	11,30	
AIRWAYS, NASOPHARYNGEAL		
Adjustable Flange, Disposable, Latex Free.....	9	
Soft PVC Style, Latex.....	9	
AIRWAYS, ORAL		
Berman, Color Coded.....	9	
Break-away.....	10	
Bronchoscope	10	
Guedel, Soft, Color Coded.....	9	
Ovassapian.....	10	
TriAir Endoscopic Airway.....	25	
Williams.....	10	
ANESTHESIA MACHINES	51,55	
ANESTHESIA MACHINE ACCESSORIES	78	
B		
BITE ME BITE BLOCK	49	
BLOOD PRESSURE MONITOR		
Vital Signs Monitor.....	56	
C		
CAPNOGRAPHY		
Capnomask CO ₂ /O ₂ Monitoring Mask, Aroma.....	12	
Capnoxygen CO ₂ Monitoring Mask.....	12	
Comfort Soft Nasal CO ₂ Cannula.....	14	
MicroCap 9 Capnograph/O ₂ Monitor.....	14,57	
Oridion Microstream Filterlines.....	15-18	
Panoramic Oxygen Mask (POM) CO ₂ /O ₂	13	
RespSense EtCO ₂ Monitor.....	14,57	
TriAir Endoscopic Airway.....	25	
CARTS AND ACCESSORIES		
Anesthesia Carts.....	19-20	
Medical Cart Accessories.....	21	
CO₂ ABSORBENTS		
Amsorb Plus.....	22	
D		
Surgical Drape Clip/Clamp.....	80	
E		
EMERGENCY PRODUCTS		
Control-Cric Cricothyrotomy System.....	11	
ENDOSCOPY		
Endoscopy Mask.....	18	
Insight Flexible Video Endoscope.....	32	
ENDOBONCHIAL TUBES		
Parker Double Lumen Left.....	23	
Robertshaw Double Left.....	23	
Double Lumen Right.....	23	
ENDOTRACHEAL TUBES & ACCESSORIES		
Endotracheal Tubes, Cuffed and Uncuffed.....	25	
Preformed RAE, Oral.....	26-27	
Preformed RAE, Nasal.....	26-27	
Parker Flex-Tip.....	24	
Parker Flex-Tip, Easycurve.....	24	
Wire Reinforced.....	24	
EYE PROTECTION		
EyePro Eyelid Occlusion Dressing.....	28	
NoPress Eye Shield.....	28	
I		
INFECTION PREVENTION		
Anesthesia Machine Hygiene Covers.....	78	
Bell Medical Disposable Blades Combination Pkg.....	44	
Bell Medical Disposable Fiber Optic Blades.....	45	
Bell Medical Disposable Green System LED Handles.....	45	
Safersonic Ultrasound Probe Covers.....	68	
INFUSION & I.V. PRODUCTS		
IV Poles, SmartStack.....	29	
PowerMATE IV Pole Power Tap.....	29	
INTUBATION AIDS		
Control-Cric Cricothyrotomy System.....	11	
Eschmann Stylets (Bougie).....	30,74	
Parker Directional Stylette.....	26,74	
Short/Stubby Laryngoscope Handle.....	38,41,43,45,46	
StyletViu Video Stylet.....	79	
L		
ANESTHESIA LABEL SYSTEM	35	
LARYNGEAL MASK AIRWAYS		
Disposable.....	48-50	
MRI Compatible.....	50	
Reinforced.....	50	
Reusable.....	50	
LARYNGOSCOPES DISPOSABLE		
Bell Medical Disposable Blades Combination Pkg.....	44	
Bell Medical Disposable Fiber Optic Blades.....	43,45	
Bell Medical Disposable Fiber Optic Handles.....	43,45	
Bell Medical Disposable Conventional Blades.....	46	
Bell Medical Disposable Conventional Handles.....	46	
BriteBlade Pro Blades.....	42	
BritePro Solo Handles.....	42	
LARYNGOSCOPE BLADES, CONVENTIONAL, REUSABLE		
LED Macintosh, Conventional.....	36	
Macintosh, Improved View, Conventional.....	36	
LED Miller, Conventional.....	36	
Specialty, Conventional.....	37	
LARYNGOSCOPE HANDLES, CONVENTIONAL, REUSABLE		
Patil-Syracuse Adj. Laryngoscope Handle.....	38	
Chrome.....	38	
Waterproof, Stainless Steel.....	38	
LARYNGOSCOPE BLADES, FIBEROPTIC, REUSABLE		
Bell Medical Macintosh.....	39	
Bell Medical Miller.....	39	
Heine/Propper Macintosh.....	41	
Heine/Propper Miller.....	41	
Heine/Propper Pediatric.....	41	
Heine/Propper Wisconsin.....	41	
Specialty Blades.....	40	
Sun-Flex Flexible Tip.....	39	
LARYNGOSCOPE HANDLES, FIBEROPTIC, REUSABLE		
Bell Medical LED.....	39,41	
Heine/Propper LED.....	41	
LARYNGOSCOPE, MRI COMPATIBLE		
MRI Blades.....	47	
MRI Handles.....	47	
MRI Batteries.....	47	
LARYNGOSCOPE VIDEO		
Insight Video Airway Management System.....	31-34	
Insight Rigid Video Laryngoscope.....	33	
Insight Video Laryngoscope.....	34	
Insight Video Laryngoscope Disposable Blades.....	31,34	
N		
NEBULIZER		
TriggerNeb "Breath Enhanced".....	72	
NEEDLES, REGIONAL ANESTHESIA		
Echogenic.....	60	
Gertie Marx Spinal.....	59	
Gertie Marx Combined Spinal/Epidural.....	59	
Sprotte Pencil Point.....	61	

Table of Contents

Bell Medical has a large product selection at www.BellMedical.com.

NERVE STIMULATORS

EZ Stim III.....	66
MiniStim.....	66
STIMPOD 450 & 410.....	62-63
STIMPOD 450 & 410 Accessories.....	62-63
SunStim, SunStim Plus and SunStim Pro.....	65
SunStim Accessories.....	65

O

OXYGEN ADMINISTRATION

Capnomask CO2/O2 Monitoring Mask, Aroma.....	12
Capnoxxygen CO2 Monitoring Mask.....	12
Comfort Soft Nasal CO2 Cannula.....	14
Panoramic Oxygen Mask (POM) CO2/O2.....	13

OXYGEN SENSORS

Anesthesia Machine Oxygen Sensors.....	67
--	----

P

PATIENT MONITORING

High Frequency HeartRate Variability Index Monitor.....	58
MicroCap 9 Capnograph/O2 Monitor.....	57
Mindray Patient Monitor Accessorie	53-54
Patient Monitors Bedside.....	52,56
Patient Monitors OR.....	52,56
RespSense EtCO2 Monitor.....	14,57
Vital Signs Monitor.....	56

POSITIONING PAD

Troop Positioning Pads.....	68
Tereboot Nerve Block Positioning Device.....	64

PULSE OXIMETERS

Adult Finger Pulse Oximeter.....	69
Child Finger Pulse Oximeter.....	69
Handheld Pulse Oximeter.....	69

R

RESPIRATORY THERAPY

Pulmodyne BiTrac NIV Masks.....	70
Pulmodyne MAX SHIELD.....	71
Pulmodyne NIV Circuit.....	71
TriggerNeb "Breath Enhanced".....	72

S

STETHOSCOPES

Precordial Chest Pieces.....	73
------------------------------	----

STETHOSCOPE ACCESSORIES

Double-stick Adhesive Disc.....	73
Esophageal Stethoscope, Disposable.....	73
Monoscope, Softear, Disposable.....	73
Temperature Cables.....	73

STYLETTES

Angled Tip Orange Disposable (Bougie).....	30,74
Eschmann Disposable (Bougie).....	30,74
Eschmann Reusable (Bougie).....	30,74
Parker Directional Stylette.....	26,74
PVC Coated Stylette.....	74
Rigid.....	30,74
StyletViu Video Stylet.....	79

SYRINGE PUMP

.....	75
-------	----

T

TEMPERATURE MONITORING

CliniTemp Temperature Strips.....	76
Ear (Tympanic) Probes.....	73,76
Esophageal Stethoscopes.....	73,76
Skin Probes.....	73,76
Temperature Cables, Reusable.....	73,76

BELL MEDICAL T-SHIRT

.....	80
-------	----

U

ULTRASOUND PROBE COVERS

Safersonic Continuous Block.....	77
Safersonic Single Shot.....	77

V

VIDEO LARYNGOSCOPE

Insight Video Airway Management System.....	31-34
Insight Flexible Endoscope.....	32
Insight Rigid Video Laryngoscope.....	33
Insight Video Laryngoscope.....	34
Insight Video Laryngoscope Disposable Blades.....	31,34

Bell Medical has specialized in anesthesia equipment and supplies since 1975. We are a specialty distributor that is dedicated to introducing new technologies that enhance the anesthesia provider's ability to deliver safe patient care. We are headquartered in St. Louis, Missouri and have sales representatives throughout the United States and Canada.

Bell Medical is committed to delivering high quality products and the best possible customer service. Thank you for considering the products and services in this catalog and on our website. Your business is appreciated.

Sincerely,



Kevin Lueders
President and CEO



Bell Medical has informational product videos on YouTube.

Find more products online at www.BellMedical.com or call 800-875-BELL (2355).

A

AESTHESIA MACHINE ACCESSORIES

Cast-R-Gard
Cord Caddy

B

BLOOD AND FLUID WARMING

Blood Warmer, Hemokinetitherm
Hemocoils, Disposable

BLOOD PRESSURE CUFFS

Disposable, Cotton, Latex Free
Manual BP Kit
Neonatal
Reusable

BLOOD PRESSURE CUFF ACCESSORIES

Bulbs & Valves
Tubing, Coiled & Straight, Connectors

BLOOD PRESSURE SPHYGMOMANOMETERS

Gauge
Hand Aneroid, Mercurial

BREATHING BAGS

Adult, Pediatric
Disposable, Latex Free, Reusable

BREATHING CIRCUITS

Adult, Pediatric
Expandable
Jackson Rees, Mapleson D
Latex-Free

BREATHING TUBES

Breathing Tube
Gas Evacuation & Scavenging
Ventilator Hose

BREATHING TUBE ACCESSORIES

Gas Sampling Connectors, Filters, Lines
Nafion (Semi-permeable) Tubing
Reservoir for Auxiliary Water Traps
Tube Support

C

CHAIRS

Anesthesia Chair

CONNECTORS & ADAPTERS

Disposable Flex Adapter
Flexible, Racine Universal, Swivel Adapter

CYLINDER CARTS

Multiple D & E Cylinder
Single D & E Cylinder
Single H (Large) Cylinder

E

EMERGENCY PRODUCTS

Abelson Jaw Spreader
Resuscitation Mask
Tracheostomy Kit
Variable PEEP Valve

ENDOBONCHIAL PRODUCTS

Carlens Tube
Dr. White Tube
Robertshaw Tube

ENDOTRACHEAL TUBES & ACCESSORIES

Curved Wire Reinforced
Endotest
Safety Clear Murphy, with Cuff
Safety Clear Murphy, without Cuff

F

FACE MASKS

Ambu Type, Reusable
Anatomical, Reusable
Patil-Syracuse, Reusable
Rendell-Baker Syracuse (RBS), Reusable
Clear Comfort, Disposable

FACE MASK ACCESSORIES

Diaphragm, Replacement for Patil-Syracuse
Head Harness, Black
Hook Ring for Ambu Type Facemask
Williams Airway Intubator, Reusable

FILTERS - BACTERIA/VIRAL

Anesthesia
Gas Sampling Disk

H

HEAT & MOISTURE EXCHANGERS

I

INTUBATION AIDS

Abelson Jaw Spreader
Aillon Tube Bender
Howland Lock
Magill Forceps
Patil Intubation Whistle
Patil-Syracuse Adj. Laryngoscope Handle
Stylette, Infant, Stainless Steel
Tooth Protector

INFUSION & I.V. PRODUCTS

Arterial Cannulation Positioner
Restraint Strap, Soft-Touch, D-Ring
Woods Pump, Rapid Fluid Infusion
Unifusor, Disposable, Pressure Infusion Cuff

J

JET VENTILATION & ACCESSORIES

Copper Tube with Luer Connection
Jet Ventilator System
Wall Adapter Fitting, O2

L

LARYNGOSCOPE ACCESSORIES

Carrying Case
Howland Lock

LARYNGOSCOPES, FIBEROPTIC

Upsher System

LARYNGOSCOPE LAMPS

American Standard, Clear
American Standard, Frosted
FOCS Halogen
Halogen
Upsher Fiber Optic

O

OXYGEN ADMINISTRATION

Oxygen Masks
Oxygen Supply Tubing

OXYGEN MONITORS

Max O2 Analyzer
Max O2 Monitor

P

PEEP VALVES

Reusable, Adjustable, Magnetic Reusable,
Fixed

S

STETHOSCOPES

Disposable
Littman Type
Master Cardiology
Sprague/Rappaport Type

SUCTION

Suction Catheter
Suction Supplies

SUCTION COLLECTION

Carrier, Collection Canisters
Holder, Single Canister
Mounting Kit, Regulator

T

TRACHEOSTOMY TUBES

Cuffed and Uncuffed Tracheostomy Tube
Cuffed and Uncuffed Fenestrated
Extra Length Blue Line
Inner Cannulas

TUBE CHANGERS

Endotracheal Tube Changer
Jettx Jet Ventilation Tracheal Tube Exchanger
Sheridan T.T. Tracheal Tube Exchanger

V

VENTILATORS, JET

Copper Tube with Luer Connection
Jet Ventilator
Wall Outlet O2 Adapters

AIRWAYS

Disposable Nasopharyngeal Airway (10/box)



- Latex free
- Single patient use
- Soft PVC
- 10/box

B010884	10 French, 2.5 MM	\$19.80	B010888	18 French, 4.5 MM	\$19.80
B010885	12 French, 3.0 MM	\$19.80	B010889	20 French, 5.0 MM	\$19.80
B010886	14 French, 3.5 MM	\$19.80	B010890	22 French, 5.5 MM	\$19.80
B010887	16 French, 4.0 MM	\$19.80	B010891	24 French, 6.0 MM	\$19.80
			B010892	26 French, 6.5 MM	\$19.80
			B010893	28 French, 7.0 MM	\$19.80
			B010894	30 French, 7.5 MM	\$19.80
			B010895	32 French, 8.0 MM	\$19.80
			B010896	34 French, 8.5 MM	\$19.80
			B010897	36 French, 9.0 MM	\$19.80
			B010898	38 French, 9.5 MM	\$19.80
			B010899	40 French, 10.0 MM	\$19.80

Disposable Nasopharyngeal Airway with Adjustable Flange (10/box)



- Latex free
- Soft adjustable flange
- Single Patient use
- 10/box

B010712	12 French	\$55.15
B010714	14 French	\$55.15
B010716	16 French	\$55.15
B010718	18 French	\$55.15
B010720	20 French	\$55.15
B010722	22 French	\$55.15
B010724	24 French	\$55.15
B010726	26 French	\$55.15
B010728	28 French	\$55.15
B010730	30 French	\$55.15
B010732	32 French	\$55.15
B010734	34 French	\$55.15
B010736	36 French	\$55.15

Color Coded Soft Guedel Oral Airway (50/bag)



- Latex free plastic
- Color coded for size
- Single use
- Non-sterile
- Bulk packages
- 50/bag

B010050	50mm, Infant, Blue	\$34.00
B010060	60mm, Pediatric, Black	\$34.00
B010070	70mm, Child, White	\$34.00
B010080	80mm, Sm Adult, Green	\$34.00
B010090	90mm, Adult, Yellow	\$34.00
B010000	100mm, Lg Adult, Red	\$34.00

Berman Airway, Color Coded (50/bag)



- Latex free plastic
- Economical
- Single use
- Non-sterile
- Bulk packages
- 50/bag

B010240	40mm, Neonatal, Pink	\$17.50
B010250	50mm, Infant, Blue	\$17.50
B010260	60mm, Pediatric, Black	\$17.50
B010270	70mm, Child, White	\$17.50
B010280	80mm, Small Adult, Green	\$17.50
B010290	90mm, Adult, Yellow	\$17.50
B010200	100mm, Lg Adult, Lavender	\$17.50
B010211	110mm, X-Lg Adult, Orange	\$17.50

AIRWAYS

Break-away Intubation Airway, Disposable

The Bell Medical Break-away Intubating Airway is an intubation airway designed for use with a flexible endoscope. The Break-away Airway is designed to function as an intubation guide to direct the flexible scope through the vocal cords and as a bite block to protect the fiber optic scope. It fits ET tube sizes up to 9.0mm ID. The disposable airway has the ability to split open to allow the airway to be removed once the endoscope is through the vocal cords and patient is intubated.



- Easy Intubation Guide
- Designed for flexible endoscopes
- Fits up to 9.0mm ET Tubes

B510015	Break-away Intubation Airway, Size 8	\$297.50	50/Box
B510010	Break-away Intubation Airway, Size 8	\$70.00	10/Box
Individually Packaged (IP)			
B510015P	Break-away Intubation Airway, Size 8, IP	\$327.25	50/Box
B510010P	Break-away Intubation Airway, Size 8, IP	\$77.00	10/Box

Ovassapian Intubating Airway, Disposable (5/bag)

Intubating airway designed for use with a fiber optic endoscope. Designed to minimize the risk of disconnection or displacement of the positioned endotracheal tube. Tubular proximal half functions as a bite block. Fits Tube sizes up to 9.0 mm ID. Individually packaged.



B120040	Ovassapian Airway, 5/pk	\$40.95
----------------	--------------------------------	----------------

Bronchoscope Airway, Disposable (10/bag)

The lumen is large enough to guide the scope and ET Tube. The length is designed to form a path leading to the glottis. The device has a breakaway quality for easy removal after intubation. The external biteblock protects the flexible scope.

- Sterile



B120049	Size 0 for up to 4.5mm ET Tube, 36mm Length	\$52.00
B120042	Size 2 for up to 7.0mm ET Tube, 65mm Length	\$52.00
B120044	Size 4 for up to 9.0mm ET Tube, 85mm Length	\$52.00

Williams Airway, Disposable (10/bag)

Use once then discard. The airway intubator is cylindrical on the proximal half and open on the distal half of the lingual surface. The airway intubator is indicated for use as an oral pharyngeal airway, a means of intubating the trachea, and a guide for fiberoptic laryngoscope placement.



B120015	9cm for use with up to 7.5ID endotracheal tube	\$43.25
B120016	10cm for use with up to 8.5ID endotracheal tube	\$43.25

AIRWAYS - CRICOTHYROTOMY

Control-Cric™ Cricothyrotomy System

The Control-Cric System is a simplified surgical approach to a cricothyrotomy that helps to maintain control during a high-stress situation. The Control-Cric has a 10mm long dual sided blade with an integrated sliding trach-hook. The Control-Cric has a pre-shaped stylet that provides airway confirmation with tactile feel of the tracheal rings, along with a 5.5mm ID soft silicone cric-tube with cuff.

- Easy to use!
- 5 Year Shelf Life!
- Cost Effective!
- Saves Lives!



Sliding Tracheal Hook slides over the dual sided blade and into the incision site to help you maintain your airway.

Look for the
Control-Cric Video
on YouTube.



B080320	Control-Cric System	\$200 Each*
B080320B	Control-Cric System	\$900 5/Box*
B080329	Training Control-Cric	\$110 Each†
B080329B	Training Control-Cric	\$1,000 10/Box†

*Sterile, †Non-Sterile

Order Online: www.BellMedical.com customerservice@BellMedical.com

CAPNOGRAPHY

Capnomask™ O2/CO2 Mask with Aromatherapy

The Capnomask™ is ideal for monitored anesthesia cases (MAC) and for use in the PACU. Capnomask™ provides oxygenation while safely monitoring capnography.

- Vanilla scented to help reduce nausea and vomiting
- Capnomask™ is latex free
- Soft transparent DEHP free PVC
- Nose clip and elastic straps for easy adjustment
- O2 line and CO2 monitor line pre-attached for speedy hook-up
- 0.22 micron filter to reduce risk of cross contamination and infection

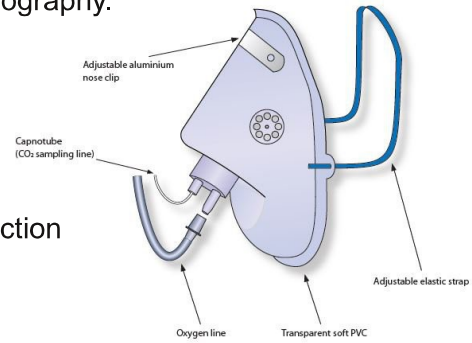

Capnomask™ Includes: O2 mask, 7' O2 tubing, 10' MxM CO2 sample line with filter

B180155	Adult mask, O2/CO2	\$220.00 50/Box
B180151	Ophthalmic mask, O2/CO2	\$220.00 50/Box
B180152	Pediatric mask, O2/CO2	\$220.00 50/Box

Vanilla scented!



Capnoxigen O2/CO2 Sampling Mask

A consistent means to monitor breathing on non-intubated patients. The CAPNOXYGEN™ mask incorporates a bevel tip sample tube in the mid dome of a medium concentration oxygen mask. Simply connect the male end of the sample line from any sidestream CO2 sample system to the female luer connector on the CAPNOXYGEN™ mask.



B180050	Adult CAPNOXYGEN™	\$110.00/25
B180052	Pediatric CAPNOXYGEN™	\$110.00/25

Adult CAPNOXYGEN™ Mask w/8' Sample Line	B180055	\$134.00/25
Pediatric CAPNOXYGEN™ Mask w/8' Sample Line	B180056	\$134.00/25

CAPNOGRAPHY

POM Procedural Oxygen and Capnography Mask (30/case)



Procedural Oxygen Mask (POM): Procedural Sedation Mask (O₂/CO₂) for upper GI procedures. POM is designed for ERCP, EUS, and EGD procedures.

- Dual oral and nasal entry ports for endoscopes
- Optimizes oxygen concentration during conscious sedation
- Measures capnography reliably even at high oxygen flows
- Allows easy unobstructed access to the patient
- Ideal for Oral or Nasal fiber optic intubations

Adult POM Options:

B180165	POM EZ-Lite w/O ₂ tubing, female luer mask connector	\$225.00
B180167	POM EZ-Lite w/O ₂ tubing, MxM CO ₂ sample line	\$245.00
B180168	POM EZ-Lite w/O ₂ tubing, MxF CO ₂ sample line	\$245.00
B180160	POM Elite w/O ₂ tubing, reservoir bag, MxM CO ₂ sample line	\$255.00
B180161	POM Elite w/O ₂ tubing, reservoir bag, MxF CO ₂ sample line	\$255.00

Pediatric POM Options:

B180165P	POM EZ-Lite w/O ₂ tubing, female luer mask connector	\$225.00
B180167P	POM EZ-Lite w/O ₂ tubing, MxM CO ₂ sample line	\$245.00
B180168P	POM EZ-Lite w/O ₂ tubing, MxF CO ₂ sample line	\$245.00
B180160P	POM Elite w/O ₂ tubing, reservoir bag, MxM CO ₂ sample line	\$255.00
B180161P	POM Elite w/O ₂ tubing, reservoir bag, MxF CO ₂ sample line	\$255.00

Oridion Microstream Compatible Adult POM Options:

B180166	POM EZ-Lite w/O ₂ tubing, Microstream connector	\$351.00
B180163	POM Elite w/O ₂ tubing, reservoir bag, Microstream connector	\$360.00

Oridion Microstream Compatible Pediatric POM Options:

B180166P	POM EZ-Lite w/O ₂ tubing, Microstream connector	\$351.00
B180163P	POM Elite w/O ₂ tubing, reservoir bag, Microstream connector	\$360.00

CAPNOGRAPHY

Comfort Soft Nasal Cannulas for CO2 Monitoring and O2 Delivery



Microcap 9

**Order Comfort
Cannula and receive
FREE Capnography
Monitor**

800-875-2355 for details



RespSense

\$181.25 per box of 25

\$89.00 per box without free monitor

Adult Comfort Soft Plus Cannulas, 10' O2 and CO2 Lines, **Male Luer and Female connector option included.**

B180030

Pediatric Comfort Soft Plus Cannulas, 7' O2 and 7' CO2 Lines, **Male Luer**

B180035

\$688.75 per case of 100

\$356.00 per case without free monitor

Adult Comfort Soft Plus Cannulas, 10' O2 and CO2 Lines, **Male Luer and Female connector option included**

B180030C

Split cannula provides high quality EtCo2 sampling from one side and oxygen delivery from the other with less dilution of CO2 sample.

Bell Medical Guarantee!
Minimum 3% savings compared to any competitors catalog pricing.

CAPNOGRAPHY

Oridion Compatible Capnography

Bell Medical Oridion compatible capnography supplies are designed to work with Oridion enabled monitors.

Procedural Sedation – GI, Cath/EP Lab, IR, ED



O2/CO2 Oral/Nasal 7' Capnography Line Plus with Filter and 7' O2 Tubing, 25/box

B203325R	Adult with Oral Scoop(009822)	\$236
B203325RL	Adult with Oral Scoop, 14' Long (009826)	\$246
B203068R	Pediatric w/Oral Scoop(007269)	\$224



O2/CO2 Nasal 7' Capnography Line with Filter and 7' O2 Tubing, 25/box

B203311R	Adult Dual Sampling(006912)	\$189
B203311RL	Adult Dual Sampling, 14" Long (007739)	\$199
B203311RS	Adult w/Split Cannula (006912)	\$181
B203311RSL	Adult w/Split Cannula, 14' Long (007739)	\$191
B203310RS	Pediatric w/Spilt Cannula(006913)	\$189

Patient Controlled Analgesia (PCA) Applications



Adult O2/CO2 Oral/Nasal 7' Capnography Line H Plus with Filter & Nafion Tubing, w/7' O2 Tubing, Long Term, 25/box

B203069R	Adult (010433)	\$329
B203069RL	Adult, 14' Long (012463)	\$339
B203369R	Pediatric (010582)	\$359



Intubated Patient Application

Adult/Pediatric Intubated Airway Set
7' Capnography Line Filter (XS-04620)

B203316R	\$173
----------	-------



Adult/Pediatric Intubated Airway Set 7' Capnography
Line, Filter & Nafion Tubing, Long Term (XS-04624)

B203314R	\$294
----------	-------

*Bell Medical Guarantee!
Minimum 3% savings
compared to any competitors
catalog pricing.*

CAPNOGRAPHY

Oridion Compatible Capnography

Bell Medical Oridion compatible capnography supplies are designed to work with Oridion enabled monitors.

Single port nasal capnography line is ideal for codes and resuscitation.

Emergency Nasal Capnography Line, Single Port, Filter, CO2 only, 25/box

B203060R

\$120



Capnography Converter Tubing Options



B203020W Oridion Capnography 10' Tubing, Male Luer Connector, allows non-Oridion standard cannula to attach to an Oridion enabled monitor

B203020W	\$262	25/Box
B203023W Includes Nafion Tubing	\$420	25/Box



B400216 Phasein Capnography Converter Tubing, Female Luer Connector, Filter and Nafion Tubing, allows non-Masimo Phasein standard cannula to attach to a Phasein enabled monitor

B400216 6" Length	\$1,155	25/Box
B400215 2 Meter Length	\$ 587	25/Box

Use with B203899 or B400216 Capnography Converter Tubing



Comfort Soft Plus Cannulas, 10' O2 and CO2 Lines, Male Luer with optional 2" Pigtail Female Adapter
B180030 \$89 25/box

Comfort Soft Plus Cannulas, 10' O2 and CO2 Lines, Male Luer with optional 2" Pigtail Female Adapter
B180030C \$356 100/case



Oxygen Tubing Connector, Barbed

B060100 \$13.50 50/box

CAPNOGRAPHY

Medtronic/Philips Oridion Microstream Capnography Solutions

Procedural Sedation - GI, Cath/EP Lab, IR, ED

Smart CapnoLine® Plus with O2 Male Connector, Adult, 009818	B203327	\$297 / 25
Smart CapnoLine® Plus with O2 Male Connector, Adult, 010209	B203331	\$1,188 / 100
Smart CapnoLine® Plus with O2 Male Connector, Pediatric, 007266	B203320	\$318 / 25
Smart CapnoLine® Plus with O2 Tubing, Adult, 009822	B203325	\$337 / 25
Smart CapnoLine® Plus with O2 Tubing, Adult, 010210	B203332	\$1,348 / 100
Smart CapnoLine® Plus with O2 Tubing, Long 14' Adult, 009826	B203326	\$395 / 25
Smart CapnoLine® Plus with O2 Tubing, Long 14' Adult, 010341	B203330	\$1,580 / 100
Smart CapnoLine® Plus with O2 Tubing, Pediatric, 007269	B203068	\$320 / 25
Smart CapnoLine® Plus with O2 Tubing, Long 14' Pediatric,007743	B203329	\$428 / 25



Smart Capnoline Plus



Nasal Only Sampling

Nasal Only Sampling with O2 Tubing, Adult, 006912	B203311	\$270 / 25
Nasal Only Sampling with O2 Tubing, Adult, 010304	B203504	\$1,078 / 100
Nasal Only Sampling with O2 Tubing, Long 14' Adult, 007739	B203312	\$297 / 25
Nasal Only Sampling with O2 Tubing, Long 14' Adult, 010344	B203359	\$1,188 / 100
Nasal Only Sampling with O2 Tubing, Pediatric, 006913	B203310	\$342 / 25
Nasal Only Sampling with O2 Tubing, Infant/Neonatal, XS04476	B203309	\$386 / 25

Smart CapnoLine Guardian

with male ended O2 connector, 012528	B203350	\$438 / 25
with male ended O2 connector, 012537	B203340	\$1,752 / 100
with 7ft/2m O2 tubing, 012529	B203351	\$478 / 25
with 7ft/2m O2 tubing, 012538	B203341	\$1,912 / 100
14' long, w/ 7ft/2m O2 tubing, 012530	B203346	\$492.00 / 25
14' long, w/7ft/2m O2 tubing, 012539	B203343	\$1,968.00 / 100



Smart OmniLine™ Guardian (use with all non-Oridion monitors)

Smart OmniLine Guardian, 6.5' O2 Tubing, 012531	B203356	\$478 / 25
Smart OmniLine Guardian, 13' with O2 Tubing, 012532	B203357	\$492 / 25

Patient Controlled Analgesia (PCA) Applications

Smart CapnoLine® H Plus O2, Adult, 010433	B203069	\$470 / 25
Smart CapnoLine® H Plus O2, Adult, 010625	B203339	\$1,880 / 100
Smart CapnoLine® H Plus O2, Pediatric, 010582	B203369	\$512.50 / 25
Smart CapnoLine® H Plus O2, Pediatric Long, 012464	B203387	\$553.50 / 25



CAPNOGRAPHY

Medtronic/Philips Oridion Microstream Capnography Solutions

Intubated Patient Application

FilterLine® H (Long Term) Set

Adult/Pediatric, 7' Sample Line, XS-04624	B203314	\$376.50 / 25
Adult/Pediatric, 7' Sample Line, 010580	B203380	\$1,506 / 100
Infant/Neonate, 7' Sample Line, 006324	B203315	\$377.50 / 25
Long Adult/Pediatric, 14' Sample Line, 007737	B203317	\$479.00 / 25



FilterLine® Set

Adult/Pediatric, 7' Sample Line, XS-04620	B203316	\$247 / 25
Adult/Pediatric 7' Sample Line, 010579	B203381	\$988 / 100
Long Adult/Pediatric 14' Sample Line, 007768	B203323	\$307.50 / 25



Disposable "Positive Pressure" Endoscopy Mask

- Fiberoptic Intubation. The ET tube can follow along the bronchoscope orally or nasally through the flexible membrane. After intubation the membrane is pushed inside which allows easy removal of the mask.
- The membrane guarantees an ideal seal and therefore efficient ventilation before, during and after bronchoscopy without time pressure.
- Gastroenterology
- Trans Esophageal Echocardiography



B100650	Size 0, Newborn, 2mm Hole Membrane	\$202.00 6/box
B100651	Size 1, Infant, 2mm Hole Membrane	\$126.00 6/box
B100652	Size 3, Child, 3mm Hole Membrane	\$126.00 6/box
B100654	Size 5, Adult, 5mm Hole Membrane	\$126.00 6/box

For Gastroenterology and Trans Esophageal Echocardiography:

B100653	Size 3, Child, 5mm Hole Membrane	\$126.00 6/box
B100655	Size 5, Adult, 10mm Hole Membrane	\$126.00 6/box

Disposable Hook Ring for Endoscopy Masks

B100659 **\$11.00** **10/box**



Disposable Head Harness for Anesthesia or Endoscopy Masks

- Latex Free

B100715 **\$180.00** **50/box**

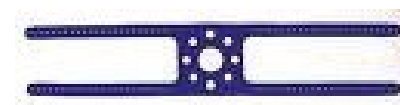

CARTS

C

Anesthesia Cart with Ultimate Accessory Package

Push Button Lock, Six (6) Drawers (3 x 3", 2 x 6", 1 x 9"), Ball Bearing Full Extension Slides, 5" Swivel Caster (Two Locking), Plastic Top



Accessory Package includes: Trellis system, 5 Tilt bin x 2, Tape dispenser, Heavy-duty railing, Divided organizer with lid, Catheter holder, Accessory bar brackets, Tray with dividers and ample holders, Utility hooks, 3" Tray x 4 w/dividers, 5" Tray x 2 w/dividers, Label holders, 12 per pkg., Wire basket, Waste container

Specify color.

B040000 (Steel Cart) \$3,075

Anesthesia Cart Basic

Key Lock, Six (6) Drawers (3 x 3", 2 x 6", 1 x 9"), Ball Bearing Full Extension Slides, 5" Swivel Caster (Two Locking), Plastic Top.

Specify color.

B040001 (Steel Cart) \$1,375

B040001A (Aluminum Cart) \$1,620



14 Standard Colors: Red, Slate Blue, Yellow, Lavender, Mauve, Sea Foam Green, Deep Blue, Taupe, Teal, Beige, Crash Cart Blue, Cranberry, Blue Gray, Hunter Green

Don't see what you are looking for here? Contact us for full cart catalog. Many additional cart configurations available!

19

CARTS

Malignant Hyperthermia Cart

Standard Package Two (2) Drawer Cart with Refrigerator includes: two (2) 16" aluminum push handles/Accessory rails, removable plastic top, bumper, 5" swivel casters - two (2) with toe locks.



Assembled Dimensions: 32" wide x 20" deep x 46¼" high

B040108 \$3,580

Optional Malignant Hyperthermia Cart Package:

IV pole, two (2) ull drawer tray with divider set, oxygen tank bracket

B040329 \$357

Difficult Intubation Cart

Six (6) Drawer Mini Tower (steel) with Push Button Lock. Measures: 43-3/4" H x 24-3/4" D x 24-1/2" W, Drawer configuration; 3 x 3", 2 x 6", 1 x 9". Includes plastic top, full extension drawers with ball bearing drawer slide, outrigger stabilizing frame, double wall construction, 5" all swivel casters - 2 locking, 1 direction, durable powder coat paint. Solid or two tone color available. Cart with Dual Scope Holder pictured.



B040120	Difficult Intubation Steel Cart Only	\$1,675
B040121	Difficult Intubation Steel Cart with Dual Scope Holder	\$2,299
B040124	Difficult Intubation Steel Cart with Quad Scope Holder	\$2,405

CART ACCESSORIES



Drawer Divider Kits

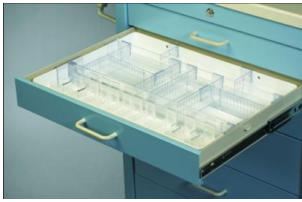

Full Drawer Tray with 8 Dividers,
14 Ampule Holders, 2 Rails
21 1/2" W x 15 1/2" D x 2 5/16" H
B040303 \$149.00



Full Drawer Tray with 6 Dividers, 2
Rails for 6", 9" and 12" Drawers
21 1/2" W x 15 1/2" D x 2 5/16" H
B040304 \$149.00

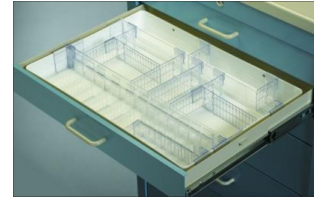

Full Drawer Tray with 7 Dividers,
18 Ampule Holders
21 1/2" W x 15 1/2" D x 2 5/16" H
B040310 \$185.00

Other drawer divider configurations available, call 800-875-2355 for information.

Oxygen Tank Bracket

Oxygen tank holder for
D/E size cylinder.
B040306 \$50.00



Introducer/Bougie Holder

- Holds up to 10 introducers
- Mounts with screws or magnets
- Clean easily through drain opening on dispenser bottom
- 2.5"W x 2.25"D x 21.125"H

B130101H \$35.00



Tape and Label Dispenser

Tape and label dispenser
for cart or table top
B040308 \$95.00

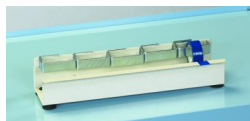

Catheter Container

Catheter container, clear front,
19" x 8" x 4"
B040307 \$114.00

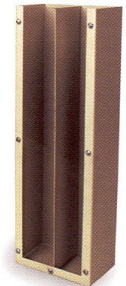

Sharps Container Bracket

Sharps Bracket only,
(container not included)
B040312 \$68.00



Plastic Waste Container

28 qt Container includes
mounting bracket (not rail).
B040311 \$70.00



IV Pole

IV bag pole to fit anesthesia
cart, 2 pronged, telescopes
13" - 36" above cart
B040313 \$128.00



Hospital Grade 6-Receptacle Outlet Strip

Six (6) receptacle outlet strip.
Hospital grade with 15' cord
B040305 \$164.00



Wide range of accessories available, call 1-800-875-2355 for information.

Order Online: www.BellMedical.com customerservice@BellMedical.com

CO₂ ABSORBENT

Amsorb® Plus Carbon Dioxide Absorbent



Amsorb® Plus is a new generation carbon dioxide absorbent, free from strong alkali metal hydroxides with **NO Sodium Hydroxide**, specifically designed for low and minimal flow anesthesia. Amsorb® Plus is the safest absorbent available with these advantages:

- GE Healthcare Endorsed and Validated December 2018
- No Toxic byproducts, No Compound A, No Carbon Monoxide, No Formaldehyde under any conditions
- APSF, Anesthesia Patient Safety Foundation recognized, 2005
- Mannion 2011 ASA Amsorb Plus Study: 25.7% Annual Anesthetic Gas Savings, 59% reduction in product usage, 83% Savings in disposal cost of non-toxic spent absorbent
- No heat or fire hazard, No degradation of anesthetic agents
- PERMANENT COLOR CHANGE, Eliminates weekly need to change absorbent in less waste economically and environmentally
- SUPERIOR PATIENT CARE AND SAFETY WITH AMSORB® Plus

Read the Mannion 2011 ASA Study 



How much Carbon Monoxide do you feel is safe for your patients to breathe?

Peak CO (ppm) from desiccated absorbent in published literature	Good  0	620	548	525	13,317  Bad	8,000	9,045
Product	AMSORB® PLUS	Drägerorb 800+	Intersorb Plus	LoFloSorb	Medisorb	Sodasorb	Spherasorb
Brand	Armstrong	Dräger	Intersurgical	Intersurgical	GE Healthcare	WR Grace	Intersurgical
Publication	Struys, 2004	Knolle, 2002	Knolle, 2002	Keijzer, 2005	Keijzer, 2005	Fang, 1995	Keijzer, 2005

B050010	1 Kg Cartridge, 2.2 lbs. (Aestiva, Mindray)	12/case	\$196.00
B050011	1 Kg Bags, 2.2 lbs.	12/case	\$169.00
B050013	Jerican, 5 liter	Twin Pak	\$ 92.00
B0500148	G-CAN (Aespire, Avance, Aisys)	8/case	\$173.75
B050016	CAN-CAN (ADU)	6/case	\$130.00
B050015	BUBBLE-CAN (Fabius GS, Draeger Clic)	6/case	\$135.00
B050019	CareCan (GE Carestation)	6/case	Call for Pricing



B0500148

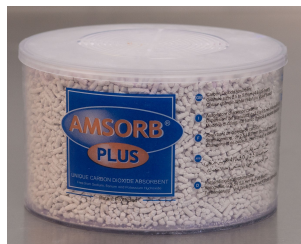

B050010



B050019



B050015

Call for contract pricing. Price match Guarantee!

Bell Medical, Inc. 314-772-5600 800-875-BELL (2355) Fax: 314-772-1233

ENDOBRONCHIAL TUBES

M

Parker Double Lumen Endobronchial Tube, Left

The Parker "No Clamp needed" Double Lumen Endobronchial Tube for the left side is constructed to help make anesthesia easier and more efficient. The Endobronchial Tube has a Y-connector with a stopcock type valve to quickly and easily cut off and supply air or scope into and out of the tube. The Y- adaptor comes preassembled making it easier than other adaptors that require assembly.

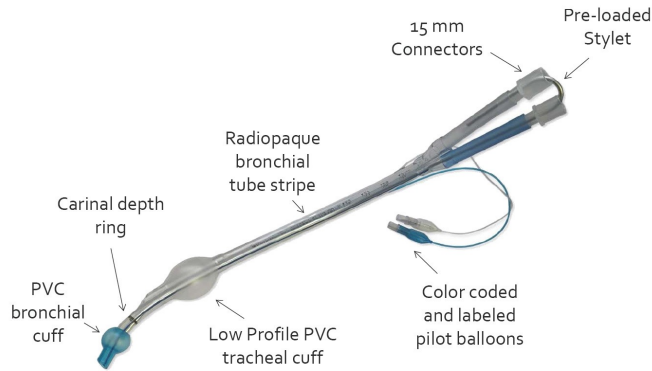

- Pre-assembled Y-connector for expediency
- 90 degree ball-valve eliminate needs for awkward clamps
- Scope and Suction catheter access in either "On" or "off" position
- Easy thread, low friction suction catheters

B090150	28 Fr	\$52.00 Each
B090151	32 Fr	\$52.00 Each
B090152	35 Fr	\$52.00 Each
B090153	37 Fr	\$52.00 Each
B090154	39 Fr	\$52.00 Each
B090155	41 Fr	\$52.00 Each

CALL FOR FREE SAMPLE!

Robertshaw Double Lumen Endobronchial Tube, Left

- Color coded clear and blue for easy differentiation of appropriate lumen, pilot balloon and cuff
- Soft PVC
- High volume, low pressure cuff
- Radiopaque strip
- Graduated depth marks
- Suction catheter included
- Bronchial stylette included
- Y 15mm connector included with each tube

B090035	35 Fr	\$68.25 Each
B090037	37 Fr	\$68.25 Each
B090039	39 Fr	\$68.25 Each
B090041	41 Fr	\$68.25 Each



Double Lumen Endobronchial Tube, Right

- Color coded clear and blue for easy differentiation of appropriate lumen, pilot balloon and cuff
- Soft PVC
- High volume, low pressure cuff
- Radiopaque strip
- Graduated depth marks
- Suction catheter included
- Bronchial stylette included
- Y 15mm connector included with each tube

B090235	35 Fr	\$75.90 Each
B090237	37 Fr	\$75.90 Each
B090239	39 Fr	\$75.90 Each
B090241	41 Fr	\$75.90 Each



ENDOBRONCHIAL TUBES

ENDOTRACHEAL TUBE - ET TUBES

Parker Flex-Tip™ Endotracheal Tubes



The patented Parker Flex-Tip Tracheal Tube has a soft, flexible, curved, centered, distal tip that is designed to prevent trauma to the delicate structures of the human airway. This tip, which is flanked by double Murphy eyes, flexes and yields as it is advanced into contact with protruding features of airway anatomy. The centered tip tends to move along the midline of the airway and the glottic opening. The tip's curvature predisposes it to "ski" gently along airway surfaces.

Parker Flex-Tip™ ET Tube, Cuffed

B092040	Size 4.0mm	10/box	\$34.95
B092045	Size 4.5mm	10/box	\$34.95
B092050	Size 5.0mm	10/box	\$34.95
B092055	Size 5.5mm	10/box	\$34.95
B092060	Size 6.0mm	10/box	\$34.95
B092065	Size 6.5mm	10/box	\$34.95
B092070	Size 7.0mm	10/box	\$34.95
B092075	Size 7.5mm	10/box	\$34.95
B092080	Size 8.0mm	10/box	\$34.95
B092085	Size 8.5mm	10/box	\$34.95
B092090	Size 9.0mm	10/box	\$34.95
B092095	Size 9.5mm	10/box	\$34.95

Parker Flex-Tip™ ET Tube, Uncuffed

B091525	Size 2.5mm	10/box	\$34.95
B091530	Size 3.0mm	10/box	\$34.95
B091535	Size 3.5mm	10/box	\$34.95
B091540	Size 4.0mm	10/box	\$34.95
B091545	Size 4.5mm	10/box	\$34.95
B091550	Size 5.0mm	10/box	\$34.95
B091555	Size 5.5mm	10/box	\$34.95
B091560	Size 6.0mm	10/box	\$34.95
B091565	Size 6.5mm	10/box	\$34.95
B091570	Size 7.0mm	10/box	\$34.95

Parker Flex-Tip™ ET Tube, Reinforced, Cuffed

B091755	Size 5.5mm	5/box	\$124.75
B091760	Size 6.0mm	5/box	\$124.75
B091765	Size 6.5mm	5/box	\$124.75
B091770	Size 7.0mm	5/box	\$124.75
B091775	Size 7.5mm	5/box	\$124.75
B091780	Size 8.0mm	5/box	\$124.75
B091785	Size 8.5mm	5/box	\$124.75
B091790	Size 9.0mm	5/box	\$124.75
B091795	Size 9.5mm	5/box	\$124.75

Parker Flex-Tip™ ET Tube, Reinforced, Uncuffed

B091630	Size 3.0mm	5/box	\$124.75
B091635	Size 3.5mm	5/box	\$124.75
B091640	Size 4.0mm	5/box	\$124.75
B091645	Size 4.5mm	5/box	\$124.75
B091650	Size 5.0mm	5/box	\$124.75
B091655	Size 5.5mm	5/box	\$124.75
B091660	Size 6.0mm	5/box	\$124.75

Parker Flex-Tip™ ET Tube, Easycurve, Articulating, Cuffed

B092015	Size 5.0mm	10/box	\$39.50
B092016	Size 6.0mm	10/box	\$39.50
B092017	Size 7.0mm	10/box	\$39.50
B092018	Size 8.0mm	10/box	\$39.50

Contact Bell Medical for the opportunity to acquire Parker Medical endotracheal tubes on our **Revenue Neutral (RN)** basic endotracheal tube plan. The plan allows hospitals to [purchase Parker basic ET tubes at the same price you pay now for standard endotracheal tubes](#) with added benefit of hospital savings on all specialty tubes!
800-875-2355

ENDOTRACHEAL TUBES - ET TUBES

High volume/low pressure cuff is designed to equalize and reduce pressure against tracheal tissue, assuring excellent seal. Sterile and latex free.

EndoTube Endotracheal Tube, Cuffed, Murphy Eye

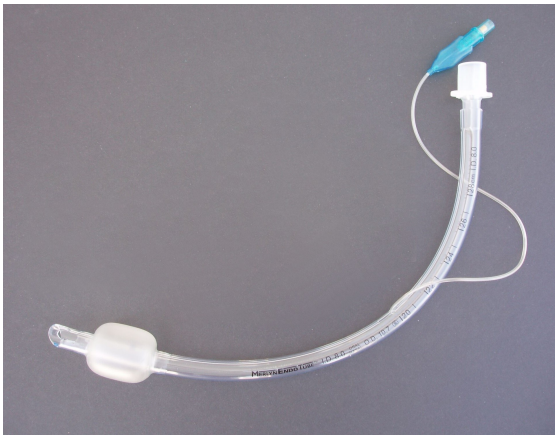

B092300	Size 3.0mm	10/box	\$14.95
B092301	Size 3.5mm	10/box	\$14.95
B092302	Size 4.0mm	10/box	\$14.95
B092303	Size 4.5mm	10/box	\$14.95
B092304	Size 5.0mm	10/box	\$14.95
B092305	Size 5.5mm	10/box	\$14.95
B092306	Size 6.0mm	10/box	\$14.95
B092307	Size 6.5mm	10/box	\$14.95
B092308	Size 7.0mm	10/box	\$14.95
B092309	Size 7.5mm	10/box	\$14.95
B092310	Size 8.0mm	10/box	\$14.95
B092311	Size 8.5mm	10/box	\$14.95

EndoTube Endotracheal Tube, Uncuffed, Murphy Eye



B092313	Size 3.0mm	10/box	\$12.00
B092314	Size 3.5mm	10/box	\$12.00
B092315	Size 4.0mm	10/box	\$12.00
B092316	Size 4.5mm	10/box	\$12.00
B092317	Size 5.0mm	10/box	\$12.00
B092318	Size 5.5mm	10/box	\$12.00
B092319	Size 6.0mm	10/box	\$12.00

Bell Medical Guarantee!
Minimum 3% savings compared to any competitors catalog pricing.

TriAir 4-In-1 Endoscopic Airway Kit

Capnography, Oxygen, BiteBlock and Airway all in one easy to use device.

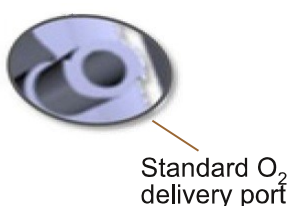
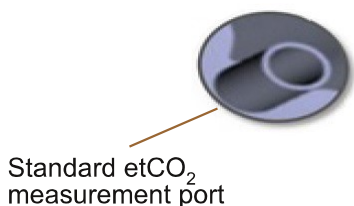

The TriAir is an all-in one device that will allow the provider to:

- Place the patient's tongue in the proper position for the introduction of the endoscope
- Protect the endoscope from the patient biting down
- Allow for introduction of O₂
- Provide the ability to monitor CO₂

B120041 Endoscopic Airway (Headstrap, 7' O₂ Line, M X M Sample Line) \$160 25/box

Order Online: www.BellMedical.com customerservice@BellMedical.com

SPECIALTY ENDOTRACHEAL TUBES

Parker Flex-Tip™ ET Tube, Preformed Nasal, Cuffed

B091295	Size 4.0mm	5/box	\$22.50
B091296	Size 4.5mm	5/box	\$22.50
B091297	Size 5.0mm	5/box	\$22.50
B091298	Size 5.5mm	5/box	\$22.50
B091290	Size 6.0mm	5/box	\$22.50
B091291	Size 6.5mm	5/box	\$22.50
B091292	Size 7.0mm	5/box	\$22.50
B091293	Size 7.5mm	5/box	\$22.50
B091294	Size 8.0mm	5/box	\$22.50

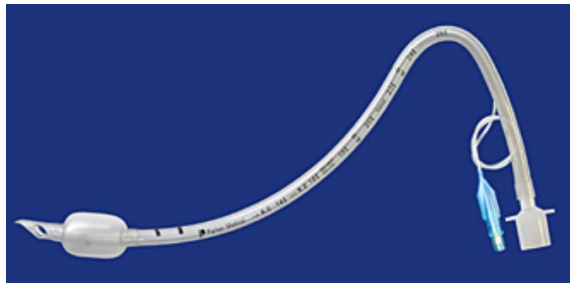

Parker Flex-Tip™ ET Tube, Preformed Nasal, Uncuffed

B091180	Size 3.0mm	5/box	\$22.50
B091181	Size 3.5mm	5/box	\$22.50
B091182	Size 4.0mm	5/box	\$22.50
B091183	Size 4.5mm	5/box	\$22.50
B091184	Size 5.0mm	5/box	\$22.50
B091185	Size 5.5mm	5/box	\$22.50
B091186	Size 6.0mm	5/box	\$22.50
B091187	Size 6.5mm	5/box	\$22.50
B091188	Size 7.0mm	5/box	\$22.50



Parker Flex-Tip™ ET Tube, Preformed Oral, Cuffed

B090880	Size 4.0mm	10/box	\$44.95
B090881	Size 4.5mm	10/box	\$44.95
B090882	Size 5.0mm	10/box	\$44.95
B090883	Size 5.5mm	10/box	\$44.95
B090884	Size 6.0mm	10/box	\$44.95
B090885	Size 6.5mm	10/box	\$44.95
B090886	Size 7.0mm	10/box	\$44.95
B090887	Size 7.5mm	10/box	\$44.95
B090888	Size 8.0mm	10/box	\$44.95
B090889	Size 8.5mm	10/box	\$44.95
B090890	Size 9.0mm	10/box	\$44.95

Parker Flex-Tip™ ET Tube, Preformed Oral, Uncuffed

B091080	Size 3.0mm	10/box	\$44.95
B091081	Size 3.5mm	10/box	\$44.95
B091082	Size 4.0mm	10/box	\$44.95
B091083	Size 4.5mm	10/box	\$44.95
B091084	Size 5.0mm	10/box	\$44.95
B091085	Size 5.5mm	10/box	\$44.95
B091086	Size 6.0mm	10/box	\$44.95



Parker Flex-It™ Directional Stylette

The Parker Flex-It Directional Stylette can be used for oral and nasal intubation and requires no pre-bending. Easy thumb action allows tube curvature to be continuously adjusted during an intubation. Its one-handed operation is designed to facilitate quick, accurate intubation, and it is especially helpful for intubating the most difficult airways.

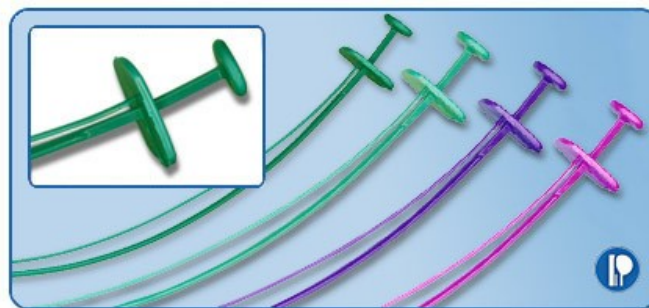

7.5 - 8.0mm Tubes	B120001	25/box	\$85.00
6.5 - 7.0mm Tubes	B120000	25/box	\$85.00
5.5 - 6.0mm Tubes	B120012	25/box	\$85.00
5.0mm Tubes	B120017	25/box	\$85.00

SPECIALTY ENDOTRACHEAL TUBES

Endotracheal Tube, Preformed Oral RAE Cuffed, Murphy Eye

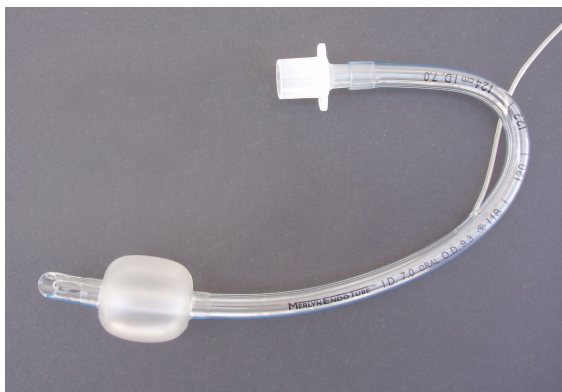

B092320	Size 3.5mm	10/box	\$36.00
B092321	Size 4.0mm	10/box	\$36.00
B092322	Size 4.5mm	10/box	\$36.00
B092323	Size 5.0mm	10/box	\$36.00
B092324	Size 5.5mm	10/box	\$36.00
B092325	Size 6.0mm	10/box	\$36.00
B092326	Size 6.5mm	10/box	\$36.00
B092327	Size 7.0mm	10/box	\$36.00
B092328	Size 7.5mm	10/box	\$36.00
B092329	Size 8.0mm	10/box	\$36.00

Endotracheal Tube, Preformed Oral RAE Uncuffed, Murphy Eye

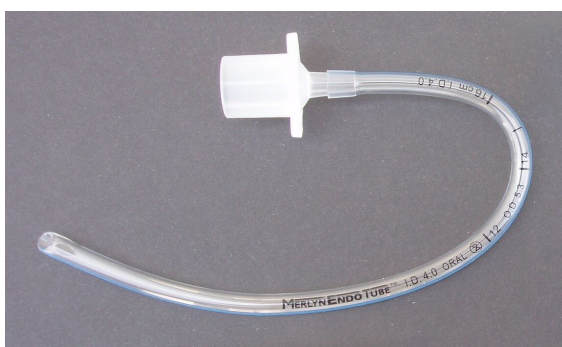

B092330	Size 3.0mm	10/box	\$36.00
B092331	Size 3.5mm	10/box	\$36.00
B092332	Size 4.0mm	10/box	\$36.00
B092333	Size 4.5mm	10/box	\$36.00
B092334	Size 5.0mm	10/box	\$36.00
B092335	Size 5.5mm	10/box	\$36.00
B092336	Size 6.0mm	10/box	\$36.00

Endotracheal Tube, Preformed Nasal RAE Cuffed, Murphy Eye



B092340	Size 3.5mm	10/box	\$36.00
B092341	Size 4.0mm	10/box	\$36.00
B092342	Size 4.5mm	10/box	\$36.00
B092343	Size 5.0mm	10/box	\$36.00
B092344	Size 5.5mm	10/box	\$36.00
B092345	Size 6.0mm	10/box	\$36.00
B092346	Size 6.5mm	10/box	\$36.00
B092347	Size 7.0mm	10/box	\$36.00

Endotracheal Tube, Preformed Nasal RAE Uncuffed, Murphy Eye



B092350	Size 3.0mm	10/box	\$36.00
B092351	Size 3.5mm	10/box	\$36.00
B092352	Size 4.0mm	10/box	\$36.00
B092353	Size 4.5mm	10/box	\$36.00
B092354	Size 5.0mm	10/box	\$36.00
B092355	Size 5.5mm	10/box	\$36.00
B092356	Size 6.0mm	10/box	\$36.00

EYE PROTECTION

EyePro Eyelid Occlusion Dressing - a clean and safe alternative to tape!

EyePro is a sterile dressing specifically designed to maintain eyelid closure during general anaesthesia while maintaining a clear view of the eyes. EyePro uses a “dual zone” adhesive system that maintains eye closure but allows safe and easy removal with minimal eyelid and eyelash trauma. EyePro will seal the eye from external insults while trapping the eye’s moisture.

Call for free samples!

EyePro benefits:

- Packaged Sterile
- Dual zone adhesive protects the eye and eye lashes when applied/removed.
- Reduces skin tears, skin irritation and redness compared to tape.
- Dual non-adhesive tabs allow for easy application and removal, even with gloves
- Each pair of EyePro come packaged together to reduce risk of cross contamination



When using tape, MRSA and/or VRE can be spread to the roll of tape and contaminate the roll for future use. Eye injuries account for 2-3% of all legal claims during anaesthesia. Tape can have damaging effects on the eye and eye lashes when removed from the patient. NoPress eye shield may be used in conjunction with EyePro to assure total patient eye safety.

B100780 EyePro Eye Protection, 100 Each (50 Pair)/Box \$50.00

NoPress Eye Shield - use with EyePro!

The NoPress is a foam and rigid shield to protect patients’ eyes from external pressure. The one-piece shield helps to distribute the pressure evenly around the bony area of the face.

Benefits of this dressing include:

- Low profile to limit snags on drapes or cords
- Transparent shield allows patients eyes to be visible at all times
- Medical grade adhesive keeps mask in place and prevents allergic reactions

NoPress is safer for the patient and easy for the clinician to use. EyePro may be used in conjunction with NoPress eye shield providing total eye safety and control.

Call for free samples!



B100781 NoPress Eye Pressure Shield, 20/Box \$100.00

INFUSION AND IV

SmartStack IV Poles



The SmartStack IV Stand from Bell Medical is what you have been waiting for in an IV Pole! Our specially designed pole base is 100% cast aluminum, providing extra stand support and durability. Its unique design will stack neatly with other bases of its kind, allowing for extra storage space, a more organized facility and easy transportation of multiple stands all at once.

- Unique stacking design with taller outer tube
- Large, smooth rolling casters with 2 wheel locks
- Includes 4 fixed Ram-horn hooks
- Easy, one-handed height adjustment
- Collapsed height of 65"; Extended height of 88"
- 48 month warranty



B130101P	Each	\$305.00
B130114 P	14-Pack	\$4,000.00

PowerMATE®

The PowerMATE® is the only IV pole mountable power tap UL approved for use in patient care areas.

- Hospital Grade
- Cord management
- Safe and convenient access to additional outlets
- Increased equipment mobility with 15 foot power cord
- 1-Year Warranty



B040399, 20 amp	\$247.00
B040398, 15 amp	\$198.00



INTUBATION TOOLS

Eschmann Stylet (Bougie) - Reusable



The reusable endotracheal tube introducer and guides are non-sterile and individually packaged.

10 French for 4.0-5.5mm tubes, Straight Tip, each	B190510	\$102.00
15 French for 6.0-11.0mm tubes, Straight Tip, each	B190513	\$102.00
15 French for 6.0-11.0mm tubes, Angled Tip, each	B190515	\$111.00
15 French for 6.0-11.0mm tubes, Angled Tip, 5/bx	B190515B	\$538.00

Rigid Stylet - Reusable

For 6.0mm tubes and larger, each



B091902 \$45.00

Eschmann Stylet (Bougie) - Disposable

The disposable endotracheal tube introducers and guides are individually packaged.

15 French for 6.0 - 11.0mm tubes, Angled Tip, Orange
(Clean and ready for patient use)

B091911	10/box	\$60.00
----------------	---------------	----------------

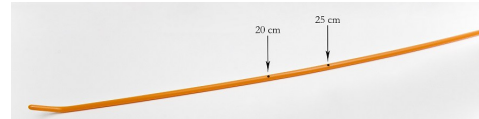

15 French for 6.0 - 11.0mm tubes, Angled Tip, Blue, Sterile

B190525	10/box	\$75.40
B190524 Bougie-To-Go	10/box	\$75.40

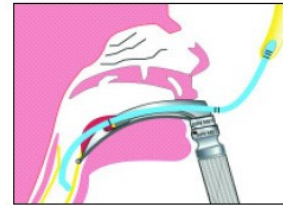

**New package option:
"Bougie-To-Go"**



10 French Pediatric, Angled Tip, Blue, Sterile	B190520	10/box	\$75.40
--	----------------	---------------	----------------

Eschmann Stylet (Bougie) with Oxygen Port - Disposable

The disposable endotracheal tube introducer and guides are sterile and individually packaged.

- Removable hose barb & 15mm Male fitting
- Coudé Tip with two eyes
- Length 70cm
- Marked to help determine depth



15 French for 6.0 - 11.0mm tubes, Angled Tip, 15mm Hose Barb	B190527	\$81.00/10
--	----------------	-------------------

- Removable 15mm O2 Connector/Luer Lock
- Coudé Tip with two eyes
- Length 65cm
- Marked to help determine depth



15 French for 6.0 - 11.0mm tubes, Angled Tip, O2 Connector	B190540	\$75.00/5
--	----------------	------------------

- Removable 15mm O2 Connector/Luer Lock
- Coudé Tip with three eyes
- Length 65cm
- Marked to help determine depth



15 French for 6.0 - 11.0mm tubes, Angled Tip, O2 Connector	B190549	\$95.00/5
--	----------------	------------------

VIDEO AIRWAY MANAGEMENT SYSTEM

Insight Video Intubation Solution for Total Airway Management



Rigid Laryngoscope

Flexible Endoscope

Video Laryngoscope

Insight video display fits Flexible Endoscope, Rigid Scope and Video Laryngoscope providing a convenient and cost effective ONE SYSTEM solution. Buy the complete system or order to your needs.

B091990	Video Laryngoscope, display, handle, recharger, case	\$3,335
B091990D	Universal display only, 16GB Video Storage	\$2,065
B09199W	Add Wifi Capability to Insight Universal Display	\$500
B091991	Infant Mac 1 Disposable Blade, 10/box	\$125/bx
B091992	Pediatric Mac 2 Disposable Blade, 10/box	\$125/bx
B091993	Adult Mac 3 Disposable Blade, 10/box	\$125/bx
B091994	Large Adult Mac 4 Disposable Blade, 10/box	\$125/bx
B091998	Rigid Laryngoscope, display, rigid malleable scope, recharger, case	\$5,335
B091998H	Rigid Laryngoscope handle only, without display	\$3,270
B091999	Flexible Endoscope, iS3-F, 4.0mm scope with display	\$7,500
B091999H	Flexible Endoscope, iS3-F, 4.0mm scope without display	\$5,435
B091999S	Flexible Endoscope, iS3-C, 5.8mm scope w/2.6mm channel, display	\$8,335
B091999SH	Flexi Endoscope, iS3-C, 5.8mm scope w/2.6mm channel, w/o display	\$6,270
B091990I	Infant Flexible Endoscope, 2.8mm scope with display	\$8,950
B091999IH	Infant Flexible Endoscope, 4.5mm scope w/1.2mm channel, display	\$9,635
B091990K	Complete Airway Management System Includes:	\$19,995
	B091990 Video Laryngoscope, handle	
	B091990D Universal display (2)	
	B091998H Rigid Laryngoscope, handle	
	B091999H Flexible Endoscope, iS3-F 4.0mm, handle	
	B091999SH Flexible Endoscope, iS3-C, iS3 5.8mm scope w/2.6mm suction channel, handle	

VIDEO AIRWAY MANAGEMENT SYSTEM

Insight Flexible Video Endoscope Solutions for Airway Management

Reusable Endoscopes are available in multiple diameters from infant to adult with and without channels to meet your flexible scope needs. High definition display with 16GB video storage is compatible with the Rigid Scope and Video Laryngoscope providing a convenient and cost effective ONE SYSTEM solution.



B091999	Flexible Endoscope, display, 4.0mm scope, recharger, case	\$7,500
B091999H	Flexible Endoscope, 4.0mm scope without display	\$5,435
B091999S	Flexible Endoscope, 5.8mm scope with display, w/ 2.6mm channel	\$8,335
B091999SH	Flexible Endoscope, 5.8mm scope w/ 2.6mm channel w/out display	\$6,270
B091990I	Flexible Infant Endoscope, 2.8mm with display	\$8,950
B091999IS	Flexible Infant Endoscope, 4.5mm with 1.2mm channel, w/ display	\$9,635
B09199W	Add Wifi Capability to Insight Universal Display	\$500

VIDEO AIRWAY MANAGEMENT SYSTEM

Insight Video Rigid “Lighted” Stylet Malleable Intubation Solution



Rigid video intubation scope with oxygen insufflation capability.

Integrated Insight video display is multi-functional fitting Rigid Scope, Flexible Endoscope and Video Laryngoscope providing a convenient & cost effective ONE SYSTEM solution.

Preload your endotracheal tube along rigid yet malleable scope locking it in place with pressure ring. View vocal cords and slide ET tube into trachea.

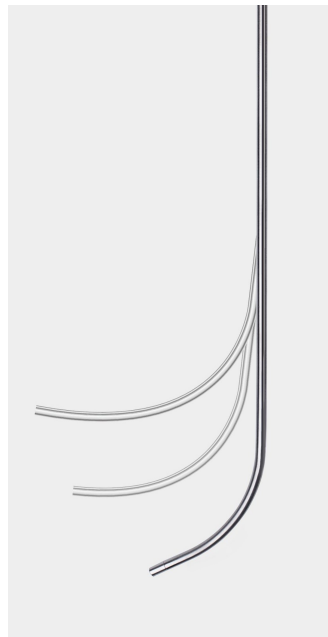

**The Future
is
Bright
with
Insight!**

- | | | |
|-----------------|---|----------------|
| B091998 | Rigid Laryngoscope, display, recharger, case | \$5,335 |
| B091998H | Rigid Laryngoscope handle only, without display | \$3,270 |
| Options: | | |
| B09199W | Add Wifi Capability to Insight Universal Display | \$500 |

VIDEO AIRWAY MANAGEMENT SYSTEM

Insight Video Laryngoscope for Infant to Large Adult: MAC 1, 2, 3 & 4!

Insight video display fits Flexible Endoscopes, Rigid Scope and Video Laryngoscope providing a convenient and cost effective ONE SYSTEM solution.

Display Features:

- High Definition 3.5" Display
- 270° Rotation and Tilt
- Infant to Adult
- 3 Plus Hour Rechargeable Battery
- Removable Display for easy gas sterilization
- Wifi to Remote Display
- Photo, Video with Sound Recording. 16GB, 70 hours of video or 80,000 photos
- Anti Fog Technology



Optional Rigid Stylets

See Clearly, Do Easily.

Call for Free Evaluation!

B091990	Video Laryngoscope, display, handle, recharger, case	\$3,335
B091991	Infant Mac 1 Disposable Blade, 10/box	\$125
B091992	Pediatric Mac 2 Disposable Blade, 10/box	\$125
B091993	Adult Mac 3 Disposable Blade, 10/box	\$125
B091994	Large Adult Mac 4 Disposable Blade, 10/box	\$125
B091902	Rigid Intubation Stylet, Reusable, Orange Handle, Each	\$45
B091996	Rigid Intubation Stylet, Reusable, Blue Handle, Each	\$24

Options:

B09199W	Add Wifi Capability to Insight Universal Display	\$500
---------	--	-------

LABELS

Vigilant+labels™ All-in-One Medication Labeling System

VIGILANT+labels™

EVERY LABEL, EVERY TIME

Everything you need to build and print personalized, compliant medication labels on-demand.



Click-to-Comply™

Anesthesia provider initials, date and time documented on each label.

- | | |
|----------|---|
| B500030 | Hardware: Click-to-Comply Anesthesia Solution |
| B500035S | Labels, 12/Label, 200/Roll |
| B500031 | Click-to-Comply 1 Year Service Agreement |
| B500033 | Click-to-Comply 3 Year Service Agreement |

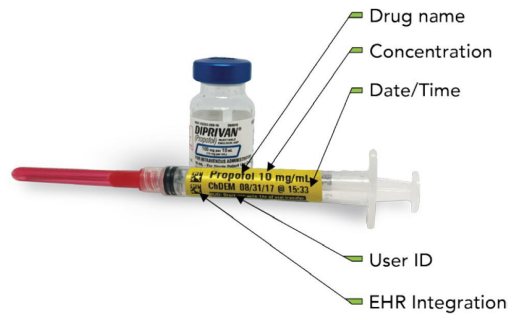

Call for a custom quotation!

- Easy to use enhancing clinical work flow
- Meets Joint Commission Standards
- Reduces need for costly prefilled syringes

Order Online: www.BellMedical.com customerservice@BellMedical.com

LARYNGOSCOPES: REUSABLE LED CONVENTIONAL

Bell Medical Conventional LED Laryngoscope Blades

- Stainless Steel
- LED Light



Macintosh

B156001	1 Infant	\$43.70
B156002	2 Child	\$43.70
B156003	3 Adult	\$43.70
B156035	3 ½ Medium Adult	\$43.70
B156004	4 Large Adult	\$43.70
B156005	5 Extra Large Adult	\$43.70

Miller (not pictured)

B156019	00 Premature	\$43.70
B156010	0 Neonate	\$43.70
B156011	1 Infant	\$43.70
B156015	1 ½ Small Child	\$43.70
B156012	2 Child	\$43.70
B156013	3 Medium Adult	\$43.70
B156014	4 Large Adult	\$43.70

LARYNGOSCOPES: REUSABLE CONVENTIONAL

Improved View / Reduced Flange Macintosh

B150396	2 Child, 100mm	\$31.00
B150397	3 Medium Adult, 130mm	\$31.00
B150398	3 ½ Medium Adult, 145mm	\$31.00
B150399	4 Large Adult, 155mm	\$31.00



Improved View Macintosh

The Improved View Macintosh blade is concave at the mid-portion and thus allows superior visualization

B150320	2 Child, 100mm	\$31.00
B150330	3 Medium Adult, 130mm	\$31.00
B150340	3 ½ Medium Adult, 144mm	\$31.00
B150350	4 Large Adult, 155mm	\$31.00



LARYNGOSCOPES: REUSABLE CONVENTIONAL

Laryngoscope Blades - Specialty

Bell Medical Conventional Laryngoscope Blades

- Stainless Steel
- Lamp Supplied with Blade

Cranwall™

B150296	0 Neonate, 75mm	\$26.00
B150297	1 Infant, 100mm	\$26.00
B150298	2 Child, 157mm	\$26.00
B150299	3 Medium Adult, 195mm	\$26.00

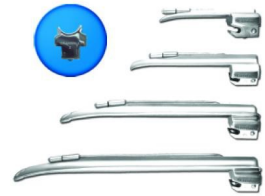

Left-Handed Macintosh

B150033	3 Adult Left, 130mm	\$31.50
---------	---------------------	---------



Phillips

B150410	1 Infant, 113mm	\$26.00
B150420	2 Adult, 166mm	\$26.00



Robertshaw

B150250	0 Newborn, 94mm	\$42.00
B150251	1 Infant, 112mm	\$42.00



Wisconsin

B150220	2 Child, 135mm	\$26.00
B150230	3 Medium Adult, 162mm	\$26.00
B150240	4 Large Adult, 199mm	\$26.00

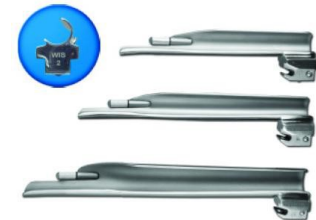

Wis-Hipple

B150246	00 Premature, 65mm	\$26.00
B150247	0 Newborn, 76mm	\$26.00
B150248	1 Infant, 102mm	\$26.00
B150249	1 ½ Small Child, 115mm	\$26.00



Sun-Flex™ Macintosh Flexible Tip Blades

B150093	3 Medium Adult, 132mm	\$145.00
B150094	4 Large Adult, 155mm	\$145.00
B150099	Kit: Sun-Flex Macintosh 3 & 4, Medium Handle Extra Reflector Lamp and Carrying Case	\$345.00



LARYNGOSCOPES: REUSABLE CONVENTIONAL

Laryngoscope Handles

Bell Medical Laryngoscope Handles

Conventional Laryngoscope Handles will fit any Conventional Blade, see pages 36-37, 46.

Standard Chrome Handle

Chrome Plated Brass.

B150640	Mini - Pediatric/Short, Lithium Battery	\$44.93
B150610	Small/Penlight, 2 x "AA" Batteries	\$23.30
B150630	Stubby/Short, 2 x "AA" Batteries	\$23.30
B150620	Medium/Standard, 2 x "C" Batteries	\$23.30
B157011	Replacement Lithium Battery	\$ 6.00



Waterproof Stainless Steel Handles

The Laryngoscope handle that can be completely immersed in liquid with the batteries left in!

B150510	Small/Penlight 2 x "AA" Batteries	\$42.50
B150515	Stubby/Short, 2 x "AA" Batteries	\$46.00
B150520	Med/Standard 2 x "C" Batteries	\$42.50

Patil-Syracuse Adjustable Laryngoscope Handle

- Blade can be positioned in four different positions: 180°, 135°, 90° standard, or 45° Howland Lock Angle
- Requires two (2) AA batteries

B120007 **\$166.00**

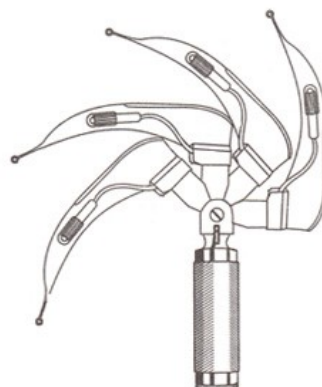

LARYNGOSCOPES: REUSABLE FIBER OPTIC

Bell Medical Integrated Fiber Optic GreenSpec German Profile Laryngoscope Blades

Built with an integral, extra large fiber optic bundle providing cool, white light. Integral fiber optic design enables superior cleaning by elimination of cracks and crevices.

Macintosh, Fiber Optic

B152200	0 Neonate	\$58.00
B152201	1 Infant	\$58.00
B152202	2 Child	\$58.00
B152203	3 Medium Adult	\$58.00
B1522035	3 ½ Medium Adult	\$58.00
B152204	4 Large Adult	\$58.00



Bell Medical Guarantee!
Minimum 3% savings compared to any competitors catalog pricing.

Miller, Fiber Optic

B153309	00 Premature	\$58.00
B153300	0 Newborn	\$58.00
B153301	1 Infant	\$58.00
B153302	2 Child	\$58.00
B153303	3 Medium Adult	\$58.00
B153304	4 Large Adult	\$58.00



Sun-Flex™ Macintosh Fiber Optic Flexible Tip Blades

B150090	3 Medium Adult, 132mm	\$268.00
B150094	4 Large Adult, 155mm	\$268.00
B150099	Kit: Sun-Flex: 3 & 4 Medium Handle Extra Reflector Lamp and Carrying Case	\$549.00



Bell Medical Reusable Handles for Fiber Optic Blades

Fiber Optic Laryngoscope Handles will fit any Fiber Optic Blade, see pages 39-44.

All with LED Light



B157100	Bell Medical, Medium/Standard C Batteries	\$96.00
B157102	Bell Medical, Compact/Slim AA Batteries	\$96.00
B157101	Bell Medical, Light/Stubby AA Batteries	\$96.00
B157025	Propper LED Light, Medium/Standard "C" Batteries*	
B157027	Propper LED Light Compact/Slim "AA" Batteries*	
B157026	Propper LED Light Short/Stubby "AA" Batteries	

Bell Brand Pictured

*Removable outer sleeve for sterilization. \$220.00/ea

LARYNGOSCOPES: REUSABLE SPECIALTY F.O.

Bell Medical Fiber Optic Specialty GreenLine Laryngoscope Blades

Improved View / Reduced Flange Macintosh, Fiber Optic

B153262	2 Child, 100mm	\$49.50
B153263	3 Medium Adult, 130mm	\$49.50
B153265	3 ½ Medium Adult, 145mm	\$49.50
B153264	4 Large Adult, 155mm	\$49.50



Improved View Macintosh, Fiber Optic

The Improved View Macintosh blade is concave at the mid-portion and thus allows superior visualization

B153252	2 Child, 100mm	\$49.50
B153253	3 Medium Adult, 130mm	\$49.50
B153255	3 ½ Medium Adult, 145mm	\$49.50
B153254	4 Large Adult, 155mm	\$49.50

Cranwall™, Fiber Optic

B153220	0 Neonate, 75mm	\$49.50
B153221	1 Infant, 100mm	\$49.50
B153222	2 Child, 157mm	\$49.50
B153223	3 Medium Adult, 195mm	\$49.50



Phillips, Fiber Optic

B153211	1 Infant, 113mm	\$49.50
B153212	2 Adult, 166mm	\$49.50

Robertshaw, Fiber Optic

B150240	0 Newborn, 94mm	\$49.50
B150241	1 Infant, 112mm	\$49.50

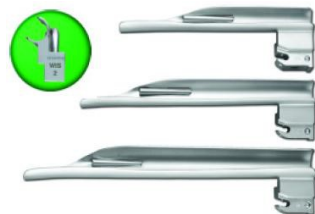

Wisconsin, Fiber Optic

B153232	2 Child, 135mm	\$49.50
B153233	3 Medium Adult, 162mm	\$49.50
B153234	4 Large Adult, 199mm	\$49.50

Wis-Hipple, Fiber Optic

B153205	00 Premature, 65mm	\$49.50
B153200	0 Newborn, 76mm	\$49.50
B153201	1 Infant, 102mm	\$49.50
B153206	1 ½ Small Child, 115mm	\$49.50



LARYNGOSCOPES: REUSABLE FIBER OPTIC

Propper/Heine Fiber Optic Laryngoscope Blades & Handles

Integrated Fiber Optic Laryngoscopes provide you with one brilliant advantage after another. Brighter light source, sterilization, flexibility, and ease of cleaning.

Propper/Heine Macintosh

B152021	MAC 1	\$147.00
B152022	MAC 2	\$147.00
B152023	MAC 3	\$147.00
B152024	MAC 4	\$147.00
B152025	MAC 5	\$147.00



Propper/Heine Miller, Wisconsin & Pediatric

B152120	#0 Pediatric	\$147.00
B152121	#1 Pediatric	\$147.00
B153126	Miller 00	\$147.00
B153120	Miller 0	\$147.00
B153121	Miller 1	\$147.00
B153125	Miller 1.5	\$147.00
B153122	Miller 2	\$147.00
B153123	Miller 3	\$147.00
B153124	Miller 4	\$147.00

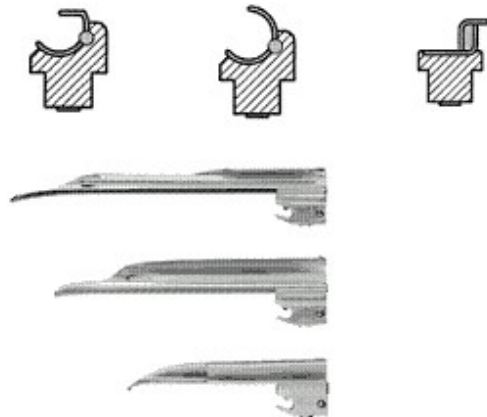

Superlume Propper LED® Laryngoscope Handles

Fiber Optic Laryngoscope Handles will fit any Fiber Optic Blade, see pages 39-44.

B157025	Propper LED Light, Medium/Standard “C” Batteries*
B157027	Propper LED Light Compact/Slim “AA” Batteries*
B157026	Propper LED Light Short/Stubby “AA” Batteries

*Removable outer sleeve for sterilization.
\$220.00 Each

B157100	Bell Medical, Medium/Standard C Batteries
B157102	Bell Medical, Compact/Slim AA Batteries
B157101	Bell Medical, Light/Stubby AA Batteries

\$96.00 Each



Propper Brand Pictured

LARYNGOSCOPES: DISPOSABLE FIBER OPTIC

BriteBlade Pro Disposable Laryngoscope Blades

BriteBlade Pro is a metal disposable fibre optic blade designed for single patient use which eliminates risk of cross contamination from both blade and handle. It has a unique hinge design that prevents the folded blade from touching the handle.



Macintosh Disposable Laryngoscope Blades

\$58.95 10/package

B151821	Mac 1	B151826	Mac 3.5
B151822	Mac 2	B151827	Mac Strong Curve
B151823	Mac 3	B151824	Mac 4

Miller Disposable Laryngoscope Blades

\$58.95 10/package

B151839	Miller 00	B151832	Miller 2
B151830	Miller 0	B151833	Miller 3
B151831	Miller 1	B151834	Miller 4

Specialty Disposable Laryngoscope Blades

\$58.95 10/package

B151851	Philips 1
B151852	Philips 2
B151860	Robertshaw 0
B151861	Robertshaw 1
B151841	Wishipple 1
B151845	Wishipple 1.5
B151842	Wishipple 2
B151843	Wishipple 3



Laryngoscope BritePro Solo Handles

Fiber Optic Laryngoscope Handles will fit any Fiber Optic Blade, see pages 39-44.

\$266.70 20/package

B151900	Complete Disposable Handle only, Medium/Standard
B151901	Complete Disposable Handle only, Mini



Mini Handle

Laryngoscope Blade with BritePro Solo Handle

Complete laryngoscope solution that combines disposable LED handle and fiber optic blade in a single, sterile pack. BritePro Solo is always ready for use when you are.

- No Risk of cross contamination

\$164.80 10/box

B151921	Handle and Mac 1	B151939	Handle and Miller 00
B151922	Handle and Mac 2	B151930	Handle and Miller 0
B151923	Handle and Mac 3	B151931	Handle and Miller 1
B151924	Handle and Mac 4	B151932	Handle and Miller 2
		B151933	Handle and Miller 3
		B151934	Handle and Miller 4

LARYNGOSCOPES: DISPOSABLE FIBER OPTIC

Bell Medical Economy Disposable Laryngoscope Blades and Handles

Single patient use Green System fiber optic metal reinforced laryngoscope blades are coupled with our high output ultra-bright LED handles to provide superior brightness to meet the most demanding intubation situations. Our disposable laryngoscopes work with reusable blades and handles.



Macintosh Laryngoscope Blades

B154310	Macintosh 0	\$42.50 10/box
B154311	Macintosh 1	\$42.50 10/box
B154312	Macintosh 2	\$42.50 10/box
B154313	Macintosh 3	\$42.50 10/box
B154314	Macintosh 4	\$42.50 10/box

Miller Laryngoscope Blades

B154320	Miller 0	\$42.50 10/box
B154329	Miller 00	\$42.50 10/box
B154321	Miller 1	\$42.50 10/box
B154322	Miller 2	\$42.50 10/box
B154323	Miller 3	\$42.50 10/box
B154324	Miller 4	\$42.50 10/box

Disposable Laryngoscope Handles

Fiber Optic Laryngoscope Handles will fit any Fiber Optic Blade, see pages 39-44.

B154300	Medium Adult	\$69.00 10/box
B154301	Slim/Pediatric	\$69.00 10/box
B154302	Stubby	\$69.00 10/box



LARYNGOSCOPES: DISPOSABLE FIBER OPTIC

Bell Medical Fiber Optic Green System Disposable Laryngoscope Blades and Handles

Single patient use Green System laryngoscope blades are coupled with our high output ultra-bright LED handles to provide superior brightness to meet the most demanding intubation situations.

Macintosh Fiber Optic Laryngoscope Blades

Single patient use, individually packaged clean, non-sterile.

B154010	Macintosh 0	\$97.00	20/bx
B154011	Macintosh 1	\$97.00	20/bx
B154012	Macintosh 2	\$97.00	20/bx
B154013	Macintosh 3	\$97.00	20/bx
B154014	Macintosh 4	\$97.00	20/bx



Miller Fiber Optic Laryngoscope Blades

Single patient use, individually packaged, clean, non-sterile.

B154029	Miller 00	\$97.00	20/bx
B154020	Miller 0	\$97.00	20/bx
B154021	Miller 1	\$97.00	20/bx
B154022	Miller 2	\$97.00	20/bx
B154023	Miller 3	\$97.00	20/bx
B154024	Miller 4	\$97.00	20/bx

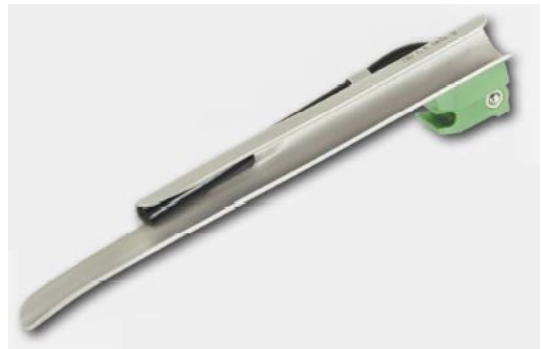

Green System Laryngoscope Handles, LED Lamps and Batteries

Aluminum with ultra-bright LED technology. Single patient use, individually packaged clean, non-sterile.

Fiber Optic Laryngoscope Handles will fit any Fiber Optic Blade, see pages 39-44.

B154000	Medium Handle	\$80.00	10/bx
B154001	Penlight Handle	\$80.00	10/bx
B154002	Stubby Handle	\$80.00	10/bx



Volume Pricing Available!

LARYNGOSCOPES: DISPOSABLE COMBO

Bell Medical Disposable Laryngoscope Blade & Handle Combination Package

Single patient use conventional LED laryngoscope blades and handles in a single ready to use package. Light weight anodized aluminum handles with pre-installed batteries. Special packaging allows easy battery and light verification before opening package.



Macintosh Laryngoscope Blades with Handles

Single patient use, individually packaged clean, non-sterile.

B154110	Macintosh 0 Small	\$113.00	10/bx
B154111	Macintosh 1 Small	\$113.00	10/bx
B154112	Macintosh 2 Medium	\$113.00	10/bx
B154112S	Macintosh 2 Stubby	\$113.00	10/bx
B154113	Macintosh 3 Medium	\$113.00	10/bx
B154113S	Macintosh 3 Stubby	\$113.00	10/bx
B1541135	Macintosh 3.5Medium	\$113.00	10/bx
B154114	Macintosh 4 Medium	\$113.00	10/bx
B154114S	Macintosh 4 Stubby	\$113.00	10/bx

Call for Contract Pricing!



Miller Laryngoscope Blades with Handles

Single patient use, individually packaged, clean, non-sterile.

B154129	Miller 00	Small	\$113.00	10/bx
B154120	Miller 0	Small	\$113.00	10/bx
B154121	Miller 1	Small	\$113.00	10/bx
B154122	Miller 2	Medium	\$113.00	10/bx
B154122S	Miller 2	Stubby	\$113.00	10/bx
B154123	Miller 3	Medium	\$113.00	10/bx
B154123S	Miller 3	Stubby	\$113.00	10/bx
B154124	Miller 4	Medium	\$113.00	10/bx
B154124S	Miller 4	Stubby	\$113.00	10/bx

LARYNGOSCOPES: DISPOSABLE CONVENTIONAL

Bell Medical Disposable Laryngoscope Conventional LED Technology Blades and Handles

Single patient use conventional LED laryngoscope blades and handles packaged separately. Light weight anodized aluminum handles with pre-installed batteries.

Macintosh Conventional Laryngoscope Blades

Single patient use, individually packaged clean, non-sterile.

B154130	Macintosh 0	\$115.00	20/bx
B154131	Macintosh 1	\$115.00	20/bx
B154132	Macintosh 2	\$115.00	20/bx
B154133	Macintosh 3	\$115.00	20/bx
B154135	Macintosh 3.5	\$115.00	20/bx
B154134	Macintosh 4	\$115.00	20/bx



Miller Conventional Laryngoscope Blades

Single patient use, individually packaged clean, non-sterile.

B154149	Miller 00	\$115.00	20/bx
B154140	Miller 0	\$115.00	20/bx
B154141	Miller 1	\$115.00	20/bx
B154142	Miller 2	\$115.00	20/bx
B154143	Miller 3	\$115.00	20/bx
B154144	Miller 4	\$115.00	20/bx



Conventional Laryngoscope Handles

Single patient use, individually packaged clean, non-sterile.

Conventional Laryngoscope Handles will fit any Conventional Blade, see pages 36-37, 46.

B150690	Medium	\$72.00	10/bx
B150691	Short/Stubby	\$72.00	10/bx
B150695	Small/Penlight	\$72.00	10/bx

Call for Contract Pricing!

LARYNGOSCOPES: REUSABLE MRI COMPATIBLE

MRI Fiberoptic Macintosh Laryngoscope Blades

(American design has flattened curve and longer light to tip distance)

B152500	MRI Compatible Laryngoscope Blade, American Macintosh 0	\$175.00
B152501	MRI Compatible Laryngoscope Blade, American Macintosh 1	\$175.00
B152502	MRI Compatible Laryngoscope Blade, American Macintosh 2	\$175.00
B152503	MRI Compatible Laryngoscope Blade, American Macintosh 3	\$175.00
B152505	MRI Compatible Laryngoscope Blade, American Macintosh 3½	\$175.00
B152504	MRI Compatible Laryngoscope Blade, American Macintosh 4	\$175.00



American Macintosh



English Macintosh

MRI Fiberoptic English Macintosh Laryngoscope Blades

(English design has full curve and shorter light to tip distance)

B152510	MRI Compatible Laryngoscope Blade, English Macintosh 1	\$175.00
B152511	MRI Compatible Laryngoscope Blade, English Macintosh 2	\$175.00
B152512	MRI Compatible Laryngoscope Blade, English Macintosh 3	\$175.00
B152513	MRI Compatible Laryngoscope Blade, English Macintosh 4	\$175.00

MRI Fiberoptic Miller Laryngoscope Blades

B152520	MRI Compatible Laryngoscope Blade, Miller 0	\$175.00
B152521	MRI Compatible Laryngoscope Blade, Miller 1	\$175.00
B152522	MRI Compatible Laryngoscope Blade, Miller 2	\$175.00
B152523	MRI Compatible Laryngoscope Blade, Miller 3	\$175.00
B152524	MRI Compatible Laryngoscope Blade, Miller 4	\$175.00

MRI Fiberoptic Wisconsin Laryngoscope Blades

B152532	MRI Compatible Laryngoscope Blade, Wisconsin 2	\$175.00
B152533	MRI Compatible Laryngoscope Blade, Wisconsin 3	\$175.00
B152534	MRI Compatible Laryngoscope Blade, Wisconsin 4	\$175.00

MRI Fiberoptic Handle (Requires MRI "C" Battery (not included))

B152550	MRI Compatible Laryngoscope Handle, Medium	\$398.00
B152551	MRI Compatible Laryngoscope Handle, Short	\$392.00

MRI Battery

B152595 MRI "C" Compatible Lithium Battery for B152550 Handle, 2/pack \$373.00

MRI Halogen Bulb

B152599 MRI Compatible Light Bulb for B152550 Handle, 5/pack \$106.00



LARYNGEAL MASK AIRWAYS

EndoMask Eclipse 100% Silicon Disposable Laryngeal Mask Airway

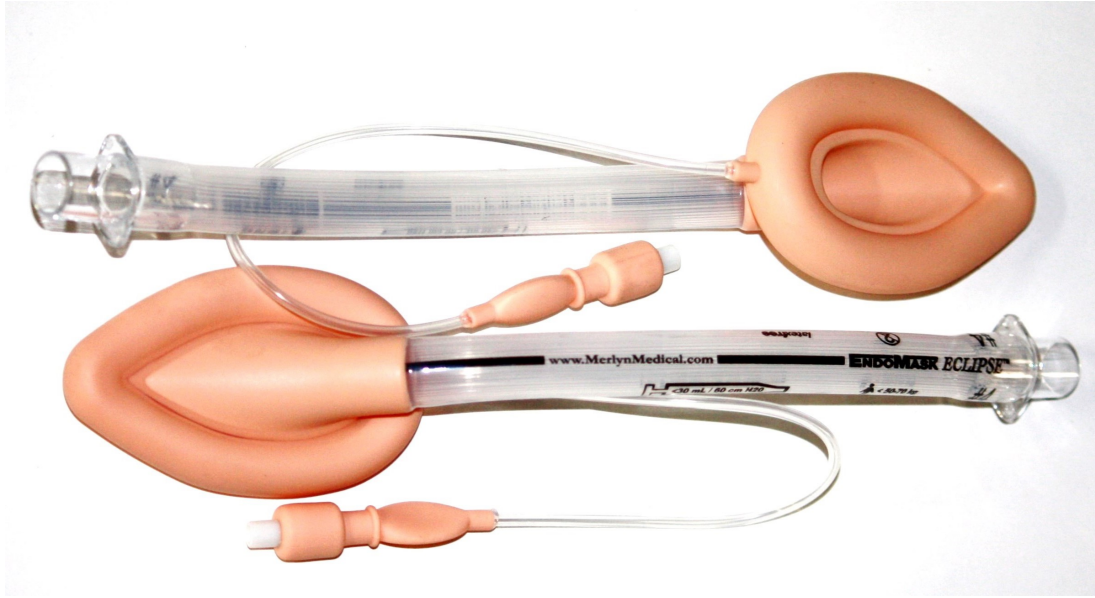

Eclipse Comfort Seal 100% Silicon LMA

- **Superior silicone cuffs** that conform to the natural contours of the hypopharynx for perfect fit, allowing rapid insertion, excellent seal, and single-hand ventilation. Cuffs are thick and durable with a smooth matte finish.
- **No epiglottic bars** (aperture bars) obstructions enable easy access for a fiberscope and suction catheters.
- **The finest premium-grade silicone** is used in the manufacture of EndoMask® products. Our cuff assembly and tube body is smoother and has less impurities within its structure than other silicone laryngeal masks.
- **Manufacture** of EndoMask is under the strictest quality control and sterile conditions. Our plant operates under certification of ISO and is compliant with FDA and CE standards.
- **All EndoMask products utilize 100 percent latex free** manufacturing and packaging materials.

EndoMask Eclipse™ single use silicone laryngeal mask Size 1	B121110	\$47.25/5
EndoMask Eclipse™ single use silicone laryngeal mask Size 1.5	B121118	\$47.25/5
EndoMask Eclipse™ single use silicone laryngeal mask Size 2	B121120	\$47.25/5
EndoMask Eclipse™ single use silicone laryngeal mask Size 2.5	B121129	\$47.25/5
EndoMask Eclipse™ single use silicone laryngeal mask Size 3	B121130	\$47.25/5
EndoMask Eclipse™ single use silicone laryngeal mask Size 4	B121140	\$47.25/5
EndoMask Eclipse™ single use silicone laryngeal mask Size 5	B121150	\$47.25/5

Bell Medical Guarantee!
Minimum 3% savings compared to any competitors catalog pricing.

LARYNGEAL MASK AIRWAYS

BiteMe™ Bite Block

BiteMe is an air-filled, bite block specifically designed to protect patient's teeth and airway devices during general anesthesia.



- Soft FDA approved food grade plastic
- Tapered distal end to allow easy placement between the teeth
- Concave side to allow close conformity when taped against airway device
- Air-filled cavity which creates compliant resistance to teeth clenching on waking up
- Depth markers to allow accurate positioning
- Distal end is blunt to decrease risk of trauma to delicate oral tissues
- Smooth finish makes it easy to insert and remove
- Single use and latex free
- Patented design
- Highly visible in the mouth
- Individually wrapped

Call 800-875-2355 for free sample.

B120029	BiteMe Bite Block Airway Protection	\$195	100/box
---------	-------------------------------------	-------	---------

Disposable Laryngeal Mask, 100% Silicone



Single use silicone laryngeal mask Size 1	B121071	\$45.00/5
Single use silicone laryngeal mask Size 1.5	B121078	\$45.00/5
Single use silicone laryngeal mask Size 2	B121072	\$45.00/5
Single use silicone laryngeal mask Size 2.5	B121079	\$45.00/5
Single use silicone laryngeal mask Size 3	B121073	\$45.00/5
Single use silicone laryngeal mask Size 4	B121074	\$45.00/5
Single use silicone laryngeal mask Size 5	B121075	\$45.00/5

LARYNGEAL MASK AIRWAYS STRAIGHT

Disposable Laryngeal Mask, 100% Silicone

- 100% Medical Grade Silicone Cuff
- Packaged Sterile; ready for use

100% Silicone Cuff & Tube \$110.00 per box of 10

B120110	Size 1.0	B120130	Size 3.0
B120115	Size 1.5	B120140	Size 4.0
B120120	Size 2.0	B120150	Size 5.0
B120125	Size 2.5	B120160	Size 6.0

100% Silicone Cuff & Tube, MRI Compatible \$125.00 per box of 10

B120210	Size 1.0	B120230	Size 3.0
B120215	Size 1.5	B120240	Size 4.0
B120220	Size 2.0	B120250	Size 5.0
B120225	Size 2.5	B120260	Size 6.0

100% Silicone Cuff & Tube, Reinforced \$250.00 per box of 10

B120310	Size 1.0	B120330	Size 3.0
B120315	Size 1.5	B120340	Size 4.0
B120320	Size 2.0	B120350	Size 5.0
B120325	Size 2.5	B120360	Size 6.0



Disposable Laryngeal Mask, Silicone Cuff with PVC Tube

- 100% Medical Grade Silicone Cuff with PVC tube
- Packaged Sterile; ready for use

Silicone Cuff with PVC Tube \$90.00 per box of 10

B120410	Size 1.0	B120430	Size 3.0
B120415	Size 1.5	B120440	Size 4.0
B120420	Size 2.0	B120450	Size 5.0
B120425	Size 2.5	B120460	Size 6.0

Silicone Cuff with PVC Tube, MRI Compatible \$115.00 per box of 10

B120510	Size 1.0	B120530	Size 3.0
B120515	Size 1.5	B120540	Size 4.0
B120520	Size 2.0	B120550	Size 5.0
B120525	Size 2.5	B120560	Size 6.0

Reusable Laryngeal Mask, 100% Silicone

- 100% Medical Grade Silicone Cuff and Tube with ABS/PC connector/valve
- All sizes available, neonate through large adult • Non-fenestrated for easier insertion of diagnostic tools

100% Silicone Cuff & Tube \$135.00 each

B120610	Size 1.0	B120630	Size 3.0
B120615	Size 1.5	B120640	Size 4.0
B120620	Size 2.0	B120650	Size 5.0
B120625	Size 2.5	B120660	Size 6.0

100% Silicone Wire Reinforced \$165.00 each

B120810	Size 1.0	B120830	Size 3.0
B120815	Size 1.5	B120840	Size 4.0
B120820	Size 2.0	B12085	Size 5.0
B120825	Size 2.5	N/A	Size 6.0

ANESTHESIA MACHINES

M

MINDRAY ANESTHESIA MACHINES

Mindray A Series Anesthesia System

The A3 Anesthesia System combines the familiarity of traditional bellows with digital technology to meet the needs of a wide range of patients in mid-acuity hospitals and ambulatory surgery centers. The intuitive user interface with touchscreen display facilitates changes in ventilation modes and settings. The A3 delivers advanced ventilation with an easy to use and cost effective anesthesia delivery system.

- 15" color touchscreen with digital flow meters and customizable settings
- 6+ modes of ventilation
- Warmed breathing system virtually eliminates internal condensation
- Automatic compliance and fresh gas compensation maintain accurate tidal volumes with a wide range of fresh gas flows and breathing circuits
- Economical single container absorber reduces compressible volume and accepts non-proprietary pre-packaged and loose fill absorbent
- Auxiliary O2 / Air flow meters deliver blended gas to reduce the risk of airway fire
- HL7 connectivity for AIMS and EMR integration
- Available with optional Mindray patient monitor (Passport 12 shown)



**Call 800-875-2355
for quotation!**

3 Year Warranty!



The 15" color touchscreen enables clinicians to easily view and select ventilation settings, so less time is spent maneuvering and more time is devoted to patient care.



Heated absorber eliminates moisture issues plus CO2 absorber can be quickly changed during case and uses non-proprietary pre-pack absorbent.

MRI Machines Available!

PATIENT MONITORS

Mindray Passport 12 Patient Monitor

- 12.1" TFT Color Touchscreen Display
- ECG, SPO2, NIBP, Temp, Resp, 2-IBP
- Thermal Recorder
- One Year Warranty

Options

- Masimo or Nellcor SPO2
- Sidestream CO2 or Oridion CO2
- Cardiac Output
- Arrhythmia
- Agent Analysis with Age related MAC
- Wireless Connectivity



- Passport 12: 3/5 Lead ECG, Nellcor SpO2, NIBP, Temp, Resp, 2-IBP, Recorder \$6,100
- Passport 12: Above configuration with EtCO2 \$8,500
- Passport 12: Above configuration with EtCO2 and Agent Analysis \$12,500

Mindray Passport 8 Patient Monitor



- 8.4" TFT Color Touchscreen Display
- ECG, SPO2, NIBP, Temp, Resp
- Thermal Recorder
- One Year Warranty

Options

- Masimo or Nellcor SPO2
- Sidestream CO2 or Oridion CO2
- 2 Invasive BP
- Cardiac Output
- Arrhythmia/ST Analysis
- Wireless Connectivity

- Passport 8: 3-5 Lead ECG, Nellcor SpO2, NIBP, Temp, Resp, and Recorder \$4,480
- Passport 8: Above configuration with EtCO2 \$6,890

MINDRAY MONITOR ACCESSORIES



Lithium-Ion Battery, 11.1V for Passport 8 and 12 and A-Series Machines

B312050 \$255.00 each

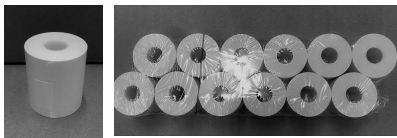

Paper, Thermal Strip, 50mm width, 30m length

B312055 \$73.35 12/box

Mindray - ETCO2



Dryline Water Trap - Adult/Pediatric

B203219B \$231.00 10/box



Gas Sampling Line, Adult/Pediatric, 10'

B030901 \$79.00 50/box



Comfort Soft ETCO2 Sampling Line with O2 delivery, Adult/Pediatric, 10', Male Connector w/ Female adapter

B180030 \$89.00 25/box

Mindray - ECG Cables and Lead Wires



ECG Cable, 3/5 Lead
B312000 \$105.00 each



ECG Operating Room Cable, 3/5 Lead, ESIS
B312001 \$125.00 each



ECG Lead Wires, 3 Lead, Snap, 24"
ECG Lead Wires, 3 Lead, Snap, 36"

B312015 \$95.00 set
B312025 \$105.00 set



ECG Lead Wires, 3 Lead, Pinch/Clip, 24"
ECG Lead Wires, 3 Lead, Pinch/Clip, 36"

B312014 \$105.00 set
B312024 \$115.00 set



ECG Lead Wires, 5 Lead, Snap, 24"
ECG Lead Wires, 5 Lead, Snap, 36"

B312019 \$135.00 set
B312029 \$145.00 set



ECG Lead Wires, 5 Lead, Pinch/Clip, 24"
ECG Lead Wires, 5 Lead, Pinch/Clip, 36"

B312018 \$145.00 set
B312028 \$155.00 set

Mindray - Nellcor SPO2

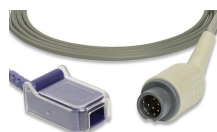

Nellcor Oximax SPO2 Cable, 8 pin"
B203030 \$280.00 each



Nellcor SPO2 Finger Sensor, Adult
B203060 \$275.00 each

MINDRAY MONITOR ACCESSORIES

Mindray Reusable NIBP Cuffs

NIBP Hose with Connectors, Reuable
B203095 \$31.00 each



Blood Pressure Cuff with Slotted Male Connectors, Reuable

- B020310 Infant/Sm Child 10-19 cm \$18.50 each**
- B020311 Child/SM Adult 18-26 cm \$20.75 each**
- B020312 Adult 25-35 cm \$23.25 each**
- B020312L Adult Long 25-35 cm \$33.50 each**
- B020313 Large Adult 33-47 cm \$31.25 each**
- B020313L Large Adult Long 33-47 cm \$35.00 each**
- B020314 Thigh 46-66 cm \$41.00 each**



Blood Pressure Cuff with Slotted Male Connectors, Reuable, Latex Free

- B020315 Infant/Sm Child 10-19 cm \$21.00 each**
- B020316 Child/SM Adult 18-26 cm \$23.25 each**
- B020317 Adult 25-35 cm \$25.75 each**
- B020318 Large Adult 33-47 cm \$33.75 each**
- B020319 Thigh 46-66 cm \$43.50 each**



Mindray Monitor Mounting Options



M Series Wall Mount with Quick Release for Passport 8 or 12
B203530 \$480.00



VHM Series Wall Mount with Quick Release for Passport 8 or 12
B203531 \$1,205.00

Roll Stand with Quick Release Mount
Passport 8 B203534 \$490.00
Passport 12 B203535 \$695.00



Bedrail Clamp (for Passport 8 pictured)
Passport 8 B203538 \$105.00
Passport 12 B203539 \$105.00

Mindray Temperature

Esophageal Stethoscope Temperature Cable, HP Plug

B190505 \$40.00



Esophageal Stethoscope w/400 Series Temperature

- 9 French B190240 50/Box \$148.00**
- 12 French B190241 50/Box \$148.00**
- 18 French B190242 50/Box \$148.00**
- 24 French B190243 50/Box \$148.00**

Skin Temperature Sensor, 400 Series
B190259 50/Box \$105.00

ANESTHESIA MACHINES

Preowned Anesthesia Machines

Bell Medical, Inc. complies with GMP (Good Manufacturing Practices) and FDA guidelines to refurbish Ohmeda and Dräger anesthesia machines. We have machines available for sale with full one year warranty.



Aestiva w/7900 Ventilator \$12,900
Aestiva w/7100 Ventilator \$10,900



Aespire w/7900 Ventilator \$18,500
Aespire w/7100 Ventilator \$16,500

**Call 800-875-2355
for Market Price!**



Dräger Fabius GS \$16,500



Mindray A5 \$18,500
Mindray A3 \$16,500

All machines come with a one year parts warranty.

Order Online: www.BellMedical.com customerservice@BellMedical.com

PATIENT MONITORS

Edan iM8 Patient Monitor



- ECG, RESP, NIBP, SPO2, 2-Temp, PR, Recorder
- 12.1" High resolution color TFT-LCD Display
- Arrhythmia, S-T Analysis, OxyCRG
- 120 Seconds Full-disclosure Waveforms Review
- 120 Hour Graphic and Tabular Trends Of All Parameters
- Bi-directional Communications with Central Monitoring System
- Pacemaker detection
- Customized alarm setting
- SP10 Accuracy Validated NIBP
- Built-in rechargeable Li-ion battery
- Nurse call, VGA Output
- Suitable for Adult, Pediatric and neonatal patients

iM8: 3/5 Lead ECG, RESP, NIBP, Edan SpO2, RESP, 2-Temp and Recorder	\$ 2,600
iM8: Above configuration with EtCO2	\$ 6,083
iM80: Above with, 4-IBP, EtCO2 and Agent Analysis	\$10,450

2 YEAR WARRANTY

Additional Configurations Available

Edan M3 Vital Signs Monitor

- 5.7 inch Color TFT Screen
- Backlight Control and Standby Mode for Power Saving Display
- Numeric and Waveform Information Simultaneously
- Nurse Call
- PR Measurement (From SpO2/NIBP) Trend table/graph view and record real time waveform printing
- USB data storage and review
- Powerful storage capacity
- Built in Lithium-ion battery for long hours of continuous working.



M3 Standard with SpO2 and NIBP	\$1,335
M3 Standard with SpO2, NIBP and Ear Temperature	\$1,780
M3 Standard with SpO2, NIBP and Covidian Oral Temperature	\$1,950

MONITORS - ETCO2

M

Nonin RespSense™ WIDESCREEN ETCO2 Monitor

Touch-panel display monitor offers MedAir™ sidestream EtCO2 technology for a wide range of clinical settings and for both intubated and non-intubated patients. Portable, accurate and cost-effective, perfect for sleep labs and procedural sedation or where fast, easy EtCO2 monitoring is required.

Key Benefits:

- Waveform trend monitoring for endotracheal tube placement verification
- Fast, first breath detection of breathing irregularities
- Extreme portability for continuous monitoring of airway integrity during transport
- Unique moisture management to prevent occlusion
- No calibration or auto zeroing required during patient monitoring for added efficiency
- WIDESCREEN™ touch-panel display
- Numerical EtCO2 and respiratory rate display
- MedAir EtCO2 technology
- 1.5 hours of EtCO2 and respiration rate waveform trending
- Backlit LCD display
- Audible and visual alarms
- Data output via RS-232 port

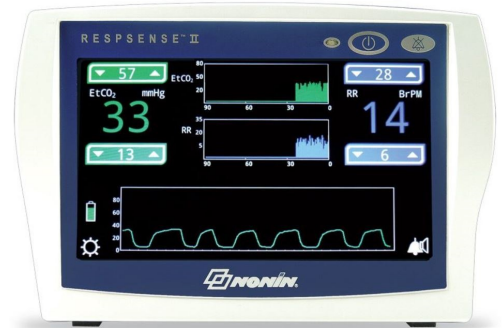

- B203900 RespSense ETCO2 Only Monitor** \$2,200
- B203901 RespSense II ETCO2 Only Monitor, Color** \$2,900
- B203902 LifeSense II ETCO2 and SPO2 Monitor, Color** \$3,400

Edan MicroCap 9 Capnograph/O2 Monitor

MoveOxy™ Pulse Oximetry Equipped with MoveOxy™ advanced digital SpO2, the MicroCap 9 handheld Capnograph and Oximeter is capable of severe monitoring conditions, providing reliable SpO2 and pulse rate measurements.

- EtCO2/CO2 range: 0 -150mmHg(0-20kPa, or 0-20%(V/V))
- Accuracy: ± 2 mmHg when 0-40mmHg $\pm 5\%$ (reading) when $> 41-70$ mmHg $\pm 8\%$ (reading) when $> 71-100$ mmHg $\pm 10\%$ (reading) when $> 101-150$ mmHg
- Update: Every breath, 10sec, 20sec or 30sec selectable
- Trend length: 24 hours

Specifications:

- Respiration Range: 3-150t/min
- Resp Accuracy: $\pm 1\%$ (reading) or ± 1 times/min whichever is greater
- Flux: 50-250cc/min selectable
- Oximetry saturation range: 0-100%
- SpO2 Accuracy: $\pm 2\%$ when 70-100% $\pm 3\%$ when 50-69%
- Range: 30-250 bpm
- PR Accuracy: ± 2 bpm or $\pm 2\%$ (reading) when 30-250bpm
- Trend length: 24 hours
- Battery type: Built-in rechargeable lithium battery
- Working time: 10 hours

- B203600 MicroCap 9 Capnograph/Oximeter Monitor** \$1,995



MONITORS - ETCO2

57

MONITORS - ANALGESIA

HFVi Monitor - High Frequency Heartrate Variability Index

The HFVi Monitor provides anesthesia providers with an easy, non-invasive monitoring system which offers an index on the amount of pain medicine needed to properly control pain during surgery and to have the patient arrive in PACU appropriately medicated.

The major benefits for this monitor are to predict postoperative pain, predict hemodynamic reactivity, to help diagnose the ethology of the hemodynamic event, and to titrate opioids to avoid overdosing.

The optimal range for the 4 minute median orange curve is to be between 50 and 70. If the index is greater than 70 the dose of pain medicine can be reduced but if it drops below 50 the patient can have hemodynamic reactivity, due to pain a few minutes later. The yellow number is an instantaneous reading.



- Quantitative window into narcotic dosing
- Enhanced OR turnover saving time
- Patient comfortable yet responsive in PACU

B500010NC	HFVi Consignment Monitor	No Cost*
B500019	HFVi Consignment Sensor	\$320 10/bx
B500019C	HFVi Consignment Sensor	\$3,000 100/bx

**Hospital must use a minimum of one sensor per monitor per day or approximately 30 per month per consignment monitor*

B500010	HFVi Monitors	\$9,500
B500019	HFVi Sensors	\$1,800 100/bx

Bell Medical, Inc. 314-772-5600 800-875-BELL (2355) Fax: 314-772-1233

NEEDLES: REGIONAL ANESTHESIA

Gertie Marx Regional Anesthesia Needles

- Conical point minimizes PDPH
- Rounded edges with sideport as small and as close to the tip as possible minimizes “failed blocks”
- Thin wall needle
- Crystal clear hub
- Raised sideport indicator

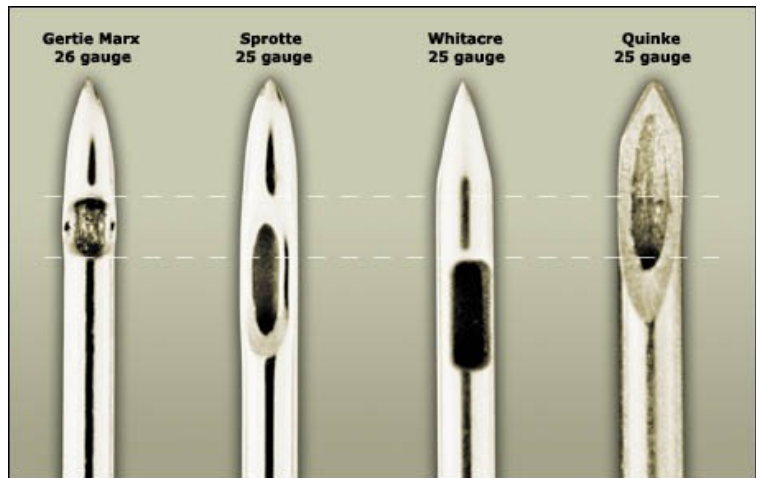

22 Gauge Needles with Introducer

B160040	50mm (2")	\$117.50	10/Box
B160041	70mm (2¾")	\$117.50	10/Box
B160001	90mm (3½")	\$117.50	10/Box
B160003	124mm (5")	\$140.00	10/Box
B160016	Spinal, 150mm (6")	\$153.50	10/Box
B160042	Spinal, 190mm (7½")	\$200.00	10/Box

24 Gauge Needles with Introducer

B160017	50mm (2")	\$117.50	10/Box
B160005	90mm (3¼")	\$117.50	10/Box
B160007	101mm (4")	\$117.50	10/Box
B160009	124mm (5")	\$140.00	10/Box
B160018	150mm (6")	\$153.50	10/Box

25 Gauge Needles with Introducer

B160019	50mm (2")	\$117.50	10/Box
B160021	90mm (3¼")	\$117.50	10/Box
B160043	101mm (4")	\$117.50	10/Box
B160023	124mm (5")	\$140.00	10/Box
B160024	150mm (6")	\$153.50	10/Box
B160026	160mm (6½")	\$153.50	10/Box
B160044	190mm (7½")	\$200.00	10/Box
B160045	215mm (8½")	\$240.00	10/Box

26 Gauge Needles with Introducer

B160047	50mm (2")	\$117.50	10/Box
B160011	90mm (3¼")	\$117.50	10/Box
B160013	101mm (4")	\$117.50	10/Box
B160015	124mm (5")	\$140.00	10/Box

27 Gauge Needles with Introducer

B160046	50mm (2")	\$117.50	10/Box
B160028	90mm (3¼")	\$117.50	10/Box
B160037	101mm (4")	\$117.50	10/Box
B160030	124mm (5")	\$140.00	10/Box
B160038	150mm (6")	\$153.50	10/Box
B160039	160mm (6½")	\$153.50	10/Box

Gertie Marx Combined Spinal with Epidural Needle

B160036	27G x 124MM Spinal Needle w/ 17G X 3½" Epidural Needle	10/box	\$240.00
B160033	26G x 124MM Spinal Needle w/ 17G X 3½" Epidural Needle	10/box	\$240.00
B160031	25G x 160MM Spinal Needle w/ 17G X 3½" Epidural Needle	10/box	\$268.00
B160034	27G x 160MM Spinal Needle w/ 17G X 5" Epidural Needle	10/box	\$268.00
B160032	25G x 190MM Spinal Needle w/ 17G X 6" Epidural Needle	10/box	\$268.00
B160035	25G x 215MM Spinal Needle w/ 17G X 7" Epidural Needle	10/box	\$320.00

NEEDLES

EchoBlock™ Echogenic Non-Insulated Needles



For Ultrasound Guided Regional Anesthesia (for those no longer using nerve stimulators)

- See the target & structures to avoid - for better accuracy and reduced needle sticks
- Increased success rate with real-time monitoring of anesthesia flow
- Faster, more accurate needle placement saves time in the Operating Room



Fixed injection tube cannot be misplaced and will not leak.

Short 30° bevel helps avoid nerve damage

1 cm calibrations around entire needles

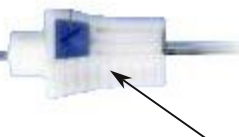

BLUE BEVEL INDICATOR
verifies bevel position

B160502	21G x 2" (50mm)	25/box	\$225.25
B160503	21G x 3 1/8" (80mm)	25/box	\$225.25
B160504	21G x 4" (100mm)	25/box	\$271.75
B160506	21G x 6" (150mm)	25/box	\$271.75

Patented Corner Cube Reflectors (CCR™) Provide multi-angled surfaces for maximum reflection even at steep angles.

- See the needle
- See the nerve
- Watch the anesthetic encircle the nerve under ultrasound



EchoStim™ Echogenic Insulated Needles

For Ultrasound Guided Regional Anesthesia (for those using nerve stimulators in conjunction with ultrasound)

- See the target & structures to avoid - for better accuracy and reduced needle sticks
- Increased success rate with real-time monitoring of anesthesia flow
- Faster, more accurate needle placement saves time in the Operating Room

Includes injection tube and standard plug that fits most stimulators.

B16052225	21G x 2" (50mm)	25/box	\$293.00
B16052325	21G x 3 1/8" (80mm)	25/box	\$330.00
B16052425	21G x 4" (100mm)	25/box	\$356.75
B16052625	21G x 6" (150mm)	25/box	\$430.00



Short 30° bevel helps avoid nerve damage

1 cm calibrations around entire needle

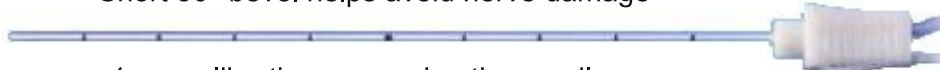

NEEDLES

Standard Sprotte® (Pencil Point) Cannula

Size	With Introducer	
25G x 150mm (6")	B161276	\$415.00 / 25
25G x 120mm (4 3/4")	B161275	\$166.00 / 10
25G x 90mm (3 1/2")	B160120	\$433.35 / 10
24G x 203mm (8")	B161271	\$313.35 / 10
24G x 150mm (6")	B161270	\$166.00 / 10
24G x 120mm (4 3/4")	B161269	\$166.00 / 10
24G x 103mm (4")	B161268	\$415.00 / 25
24G x 90mm (3 1/2")	B160116	\$433.35 / 25
22G x 203mm (8")	B161265	\$313.35 / 10
22G x 150mm (6")	B161264	\$166.00 / 10
22G x 120mm (4 3/4")	B161263	\$166.00 / 10
22G x 103mm (4")	B161262	\$415.00 / 25
22G x 90mm (3 1/2")	B161017	\$415.00 / 25
21G x 90mm (3 1/2")	B160103	\$415.00 / 25
for Lumbar Puncture		
20G x 150mm (6") Winged	B161240	\$166.00 / 10
20G x 90mm (3 1/2") Winged	B161257	\$415.00 / 25

Standard Sprotte® (Pencil Point) Cannula with Magnifying Effect/Lens

Designed for small gauges and observing smallest amounts of spinal fluid are clearly identified through a viewing chamber, safer and time saving!

Size	With Introducer	
27G x 150 mm (6")	B161249	\$313.35 / 10
27G x 120mm (4 3/4")	B161248	\$166.00 / 10
27G x 90mm (3 1/2")	B161246	\$415.00 / 25
25G x 103mm (4")	B161242	\$166.00 / 10

QUANTITATIVE TOF MONITORING

STIMPOD NMS 450X Quantitative Train-of-Four Monitor, Nerve Locator and Stimulator

One-Touch NMT

The STIMPOD NMS450X Nerve Stimulator includes a Tri-axial accelerometer which provides real time feedback of the strength of contraction of the affected limb (Train Of Four, Double Burst and Post Tetanic Count modes only). The strength of each measured contraction is displayed graphically and the relevant ratios are calculated and displayed.

QTOF endorsed by APSF and in IARS consensus statement!

Simple

- One-Touch NMT Monitoring
- Electrode Placement Verification
- Quick Setup & No Calibration
- Handheld
- Data Connectivity

Economical

- Reusable Sensor
- Standard ECG Electrode Compatible
- Quantitative NMT Monitoring reduces incidence of residual paralysis, increases operating room throughput and lowers cost

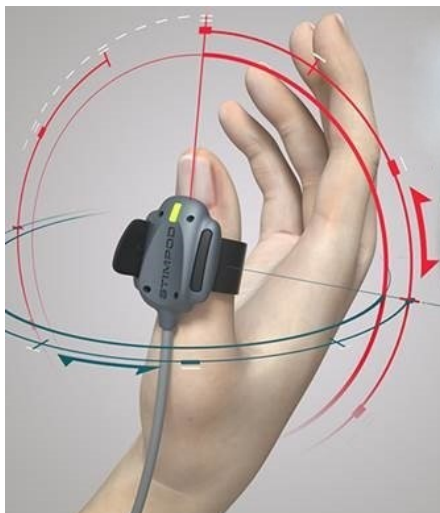

Proven

- Identifies residual paralysis
- Pioneers of quantitative monitoring technology since 1998
- Trusted by anesthesiologists in over 40 countries

Current Range

Nerve Locating: 0.0 – 5.0mA

Nerve Mapping: 0 – 20mA

NMBA Monitoring: 0 – 80mA

Stimulating Modes

Train-of-Four (TOF)

Double Burst (DB)

Post-Tetanic-Count (PTC)

Tetanus (TET)

Twitch (1Hz, 2Hz, 5Hz)

B170450 NMS450X Peripheral Nerve Stimulator Kit*

\$1,480

*Kit includes: STIMPOD NMS450X, NMBA Monitoring Cable (1.8m),

Nerve Mapping/Locating Cable, Case, Two Year Warranty on Stimpod, 6 month on cables.

Optional Accessories

B170451 STIMPOD IV Pole Mount

\$105

B170468 STIMPOD NMBA Cable with Accelerometer, 3.5m Long

\$330

B170463 3" Accelerometer Straps, package of 5

\$68

B170463L 5" Accelerometer Straps, package of 5

\$68

B17047XK EMR Communication Connectivity Cable w/Software

\$395

B17047X Replacement EMR Communication Cable only

\$295



Watch a short video on the STIMPOD

STIMPOD NMS410 - NERVE LOCATION

Stimpod NMS 410 Nerve Locator for Regional Anesthesia



Combined Nerve Mapping and Nerve Location:

Auto sensing technology provides a solution for simultaneous nerve mapping and nerve location. The Stimpod monitors whether the mapping probe or needle touches the patient and adjusts the current range accordingly, ensuring quick and precise nerve location.

The Stimpod Nerve Mapping Probe was designed to enable transcutaneous nerve mapping at higher currents (to a maximum of 20mA), whilst the tip offers a contact surface small enough to ensure effective discrimination.

Specifications:

Current Range

Nerve Locating: 0.0 – 5.0mA
Nerve Mapping: 0 – 20mA

Load Impedance

Nerve Locating: 0 – 20kΩ (100V)
Nerve Mapping: 0 – 20kΩ (400V)

Stimulating Frequency

(1Hz, 2Hz, 5Hz)

B170410 NMS410 Peripheral Nerve Stimulator Kit* \$1,150

*Kit includes: STIMPOD NMS410, Nerve Mapping/Locating Cable, Carrying Case

STIMPOD 410 & 450 Replacement Accessories

Stimpod IV Mount



B170451

NMBA Cable and Accelerometer

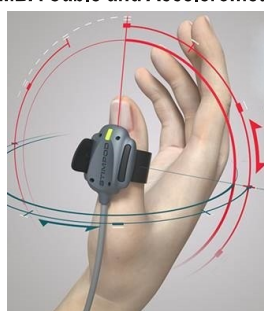

B170462 or B170468

Nerve Locating/Mapping Probe Cable



B170461

B170451	Stimpod IV Pole Mount	\$105 Each
B170462	Stimpod NMBA Cable with Accelerometer, 1.8m	\$285 Each
B170468	Stimpod NMBA Cable with Accelerometer, 3.5m	\$330 Each
B170463	Stimpod Accelerometer Straps	\$68 5/Pack
B170461	Stimpod Nerve Locating/Mapping Probe Cable	\$132 Each
B170464	Stimpod Battery Door Cover	\$15 Each

Order Online: www.BellMedical.com customerservice@BellMedical.com

NERVE BLOCK POSITIONING DEVICE

Tereboot Supine Nerve Block Positioning Device

“No more turning patients prone or lateral to perform ultrasound guided sciatic nerve blocks at the popliteal fossa. No more stacking blankets or pillows just to achieve suboptimal, unstable and uncomfortable leg elevation and positioning.”

The Tereboot is a portable and adjustable lower extremity positioning device that you place directly onto your patient's bed for supine positioned ultrasound guided popliteal fossa blocks, adductor canal blocks, saphenous blocks, ankle blocks and nerve stimulation technique popliteal fossa blocks. The disposable padding sleeves are an efficient and cost effective way to turn over the device between patients.

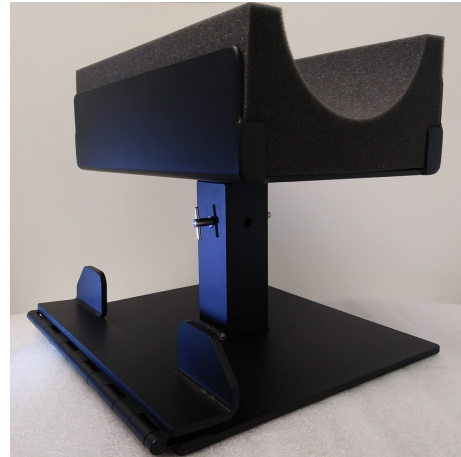

The Tereboot

- No additional space necessary - placed directly on patient's bed
- Height adjustable for patient comfort and to create ample space for the U/S probe in the posterior popliteal fossa
- Adjustable to compensate for leg rotation
- Leg stability for procedure safety and sterility
- Disposable cushion sleeves for convenience and cost effectiveness
- 5-year warranty

Supine Position

- Patient comfort and convenience
- Airway monitoring and intervention with sedation
- Procedure efficiency

Portable

- Weighs only 11 lbs
- Footprint: 11.5"x12"

Sturdy and Durable

- All metal construction - black matte finish

Adjustable

- Height
- Tilt

B180350K	Tereboot New Customer Kit (1 Tereboot Frame, 2 Pads)	\$695
B180355	Pads – set of 2	\$33
B180359	Disposable Sleeves (100)	\$65
B180359C	Disposable Sleeves (500 pack)	\$200

Never
Flip
Again!

NERVE STIMULATORS

SunStim Nerve Stimulator and Accessories

New SunStim™ Pro Peripheral Nerve Stimulator

- Easy to read illuminated digital screen functionality
- Ergonomic compact shape fits comfortably in hand
- Optional removable silicone wrap enhances grip, protects device (sold separately)
- Stimulator output current is fully adjustable from 0-70 mA
- Double burst: 2 60-ms bursts of 50 Hz separated by .75 s
- Twitch: 1 pulse per second
- Tetanus: 50 Hz (50 pulses/s) or 100 Hz (100 pulses/s)
- Built-in train of four: 4 pulses in a period of 2 seconds
- Stimulus pulse: square wave monophasic pulses (200 µs duration)
- Side switch to increase/decrease level of stimulation
- Standard battery: 9 volt alkaline
- Nerve stimulator includes battery, ball electrodes, 6' lead with clips (snap version sold separately)



B170104 \$259.95

See page 62 for Quantitative TOF

SunStim™

- Stimulator output current is fully adjustable from 0-70 mA
- Stand-by position: no stimulus pulses are generated
- Twitch: 1 pulse per second
- Tetanus: 100 Hz (100 pulses/s)
- Built-in train of four: 4 pulses in a period of 2 seconds
- Battery indicator light flashes when battery needs to be replaced
- LED (green) battery light indicates that the unit is on, flashes on low battery
- LED (red) flashes with audible indicator sounds each time a stimulus pulse is generated
- Standard battery: 9 volt alkaline
- Nerve stimulator includes battery, ball electrodes, 6' lead with clips (snap version sold separately)



B170103 \$217.45

SunStim Plus™ includes all features of B170103 plus:

- Double burst: 2 60-ms bursts of 50 Hz separated by .75 s
- Tetanus: 50 Hz (50 pulses/s) or 100 Hz (100 pulses/s)

B170101 \$225.00

SunStim Accessories and Replacement Parts

IV Pole Mount Bracket for SunStim and SunStim Plus B170118 \$134.00
IV Pole Mount Bracket for SunStim Pro B170114 \$134.00

Bipolar probe for all SunStims B170110 \$24.75

Replacement Extension Leads for all SunStims

Six foot Extension Leads with Alligator Clips: B170116 \$38.25
 Six foot Extension Leads with Snaps: B170115 \$39.50

Silicone Pro Wrap for SunStim Pro only B17012X (specify color) \$20.00
 Teal, Green, Orange, Red, Pink, Fuchsia, Purple, Blue, Gray



NERVE STIMULATORS

Halyard MiniStim Peripheral Nerve Stimulator, MS-IV

- Cost effective • Easy to use • Durable & Reliable
- Compact Design • 2-year warranty

Specifications:

- Twitch: 1 pulse per second
- Tetanus: 50 Hz - 50 pulses per second, 100Hz - 100 pulses per second
- Double Burst: Two (2) 50 Hz Trains of 60 ms duration and 750ms apart (on demand)
- Train-of-Four: 4 pulses for 2 seconds (on demand)
- Output Current: Adjustable 0-50mA
- Output Voltage: 450 volts (±10%)
- Stimulus Pulse: 220 microseconds, square wave monophasic
- Power: 9v alkaline battery
- Case: Durable ABS plastic
- Size: 2.4"L x 0.8"W x 4.2"H
- Weight: 5 ounces (142 gm)

**See page 62 for
Quantitative TOF**

B170003 \$368.00



MiniStim Replacement Parts

B170014 \$49.35 Replacement Bipolar Probe only
for MS-IV/B170003



B170012 \$41.25 Replacement 2' Leads with Alligator
Clips for MS-IV/B170003



Halyard EZ Stim III Nerve Locator and Stimulator

The dual-function, hand-held EZstim III, model ES500, operates as either a full-function nerve locator or a neuromuscular block monitor.

- Audible indicator of open circuit or high-resistance condition
- Detachable function-specific lead sets to guard against inappropriate use of stimulator
- Built-in protective bumper
- Electrosurgery compatibility

**See page 62 for
Quantitative TOF**

Call or email customer service for specifications.

B170001 \$1,860.00



OXYGEN SENSORS

Ohmeda One Year Oxygen Sensor

Ohmeda 5250 RGM, Excel Series, Module Series Hewlett Packard

B180104 \$120.00



Draeger Dual Cathode One Year Sensor

Draeger Narkomed, 6000, 8000, Evita 2, Evita 4

B180105 \$130.00



Ohmeda Two Year Extended Life Sensor

Ohmeda 5250 RGM, Excel Series, Module Series

B180102 \$175.00



Draeger Two Year Extended Life Sensor

Draeger Narkomed 2B, 2B, 3, 4

B180103 \$175.00



Ohmeda SmartVent Oxygen Sensor

Ohmeda SmartVent 7900, Aestiva

B180106 \$85.00

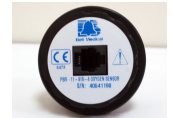

Anestar Oxygen Sensor

Datascope Anestar, Engstrom MIE, MiniOx I, II, III, Puritan Bennett 7820

B180110 \$90.00



Mindray Oxygen Sensor

Mindray A5 Anesthesia Machine

B180114 \$120.00



Penlon Oxygen Sensor

Penlon Anesthesia Machine

B180108 \$120.00



Hudson Oxygen Sensor

Hudson 5577, 6477, 5590 (replaces Hudson 5500)

B180111 \$90.00



Oxygen Analyzer Sensor

Replaces Maxtec OM-25AE, OM-25ME

B180112 \$90.00



Criticare Oxygen Sensor

Replaces Criticare 644, Air Shields, Puritan Bennett 840 Vent, Siemens 300 Series, 900 Series

B180113 \$90.00



TROOP POSITONING PADS

Troop Elevation Pillows

Designed and developed by a practicing anesthesiologist to address the inherent problem of positioning when working with larger patients.

The Troop Elevation Pillow is designed and intended to facilitate airway management for obese and large-framed patients. The pillow is for intra-op and post-op care.

B180420 **Disposable barrier covered Troop Elevation Pillow**
4/Box **\$240.00**



B180423 **Disposable barrier covers for vinyl covered Troop Elevation Pillow**
30/Box **\$148.00**



B180422 **Troop vinyl covered reusable Head Cradle**
4/Box **\$229.00**

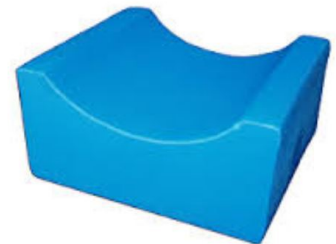

B180427 **Vinyl covered elevated arm board pads**
1 Pair/Box **\$358.00**



Troop Elevation Pillow
Ideal for Difficult Intubations
and Obese Patients.

Bell Medical Guarantee!
Minimum 3% savings compared to any competitors catalog pricing.

PULSE OXIMETRY

Adult Finger Pulse Oximeter



Features:

- Color OLED display
- Audio alarms
- Display SpO2, Pulse Rate, Pulse bar
- Blood perfusion index (PI) as low as 0.2%
- 6 display modes for easy reading from all sides.
- Battery-low indicator
- 2 AAA alkaline or rechargeable batteries
- Accommodates widest range of finger sizes from pediatric to adult
- Carrying pouch
- 1 year limited warranty

Child Finger Pulse Oximeter Plus

LED only display.

B400303

1-5 Price: \$80.00

6-24 Price: \$75.00

25+ Price: \$69.00



B400304 each \$104.00

B400303P Carrying Pouch, Orange \$3.00

Handheld Pulse Oximeter



The EDAN SpO2 technology has the equivalent performance as the industry leaders'. Its pocket-size design makes it extremely suitable for spot-checks and ambulatories.

- Compact & lightweight
- Battery charger stand design (optional)
- LCD display
- Real-time clock
- Pitch tone
- Advanced SpO2 module with equivalent performance as the industry leaders'
- Real-time measurements display
- Plethysmogram display
- Trend table and trend graphs
- Long working-time on battery only
- Large storage capacity
- Data management via PatientCare Viewer software(optional)

B400301 \$360.00

PULMODYNE BITRAC™ NIV MASKS

Pulmodyne's BiTrac Select series of noninvasive ventilation masks now has a variety of interchangeable elbows which creates multiple uses for just one mask. Along with interchangeable elbows, a selection of cushion shapes are provided to help find the right fit for patients.

BiTrac Select™ NIV Full Face Mask, Interchangeable Anti-Asphyxia Elbow 22mm Female, OmniClip™, Silicone Forehead Pad and Head Strap

Classic Cushion (PD)™

B101004	Adult Extra Large	\$219.50	10/case
B101003	Adult Large	\$219.50	10/case
B101002	Adult Medium	\$219.50	10/case
B101001	Adult Small	\$219.50	10/case

Chin Support Cushion (FP)™

B101013	Adult Large	\$219.50	10/case
B101012	Adult Medium	\$219.50	10/case
B101011	Adult Small	\$219.50	10/case

BiTrac Select™ NIV Full Face Mask, Fixed Anti-Asphyxia Elbow 22mm Female, OmniClip™, Silicone Forehead Pad

B101024	Adult Extra Large	\$214.00	10/case
B101023	Adult Large	\$214.00	10/case
B101022	Adult Medium	\$214.00	10/case
B101021	Adult Small	\$214.00	10/case

BiTrac Select™ NIV Nasal Mask with Fixed Standard

Elbow 22mm Female and Silicone Forehead Pad Classic Cushion (PD)™

B101036	Adult Large	\$177.00	10/case
B101035	Adult Medium	\$177.00	10/case
B101034	Adult Medium/Small	\$177.00	10/case
B101033	Adult Small	\$177.00	10/case

Improved OmniClip™



Call for Premiere Contract Pricing



Interchangeable Elbow Options for BiTrac MaxShield Select™

B031009	Standard (SE) Elbow, for dual limb circuit	\$45.00	10/case
B031008	Anti-Asphyxia (EE) Elbow, for single limb circuit	\$45.00	10/case
B031007	Standard (SE) Bronchoscopy Elbow, for dual limb	\$45.00	10/case
B031006	Anti-Asphyxia (EE) Bronchoscopy Elbow, single limb c	\$45.00	10/case
B031005	Standard (SE) Nebulizer Elbow, for dual limb circuit	\$45.00	10/case
B031004	Anti-Asphyxia (EE) Nebulizer Elbow, single limb circuit	\$45.00	10/case
B031003	Anti-Asphyxia (Elbow) with Leak	\$45.00	10/case
B031003A	Anti-Asphyxia (Elbow) with Leak and 22 x 22 Adapter	\$45.00	10/case

PULMODYNE BITRAC™ NIV MASKS

MAX SHIELD

Pulmodyne's BiTrac MaxShield is a full coverage NIV mask with multi-purpose fixed or interchangeable elbows. The full facial perimeter can simplify mask fitting, reduce nasal skin breakdown, and increase patient comfort.

BiTrac MaxShield Select™ with Interchangeable Anti-Asphyxia Elbow with Leak 22mm Female, and MaxShield Head Strap

B101105	Extra Large	\$359.50	10/case
B101102	Adult	\$359.50	10/case
B101104	Small Adult	\$359.50	10/case



(Pediatric sizes available - call 800-875-2355)

Interchangeable Elbow Options for BiTrac MaxShield Select™

B031009	Standard (SE) Elbow – for dual limb circuit	\$45.00	10/case
B031003	Anti-Asphyxia (Elbow) with Leak	\$45.00	10/case
B031007	Standard (SE) Bronchoscopy Elbow – for dual limb	\$45.00	10/case

BiTrac MaxShield™ with Fixed Anti-Asphyxia Elbow with Leak 22mm Female, and Head Strap

B101057	Extra Large	\$349.50	10/case
B101052	Adult	\$349.50	10/case
B101054	Small Adult	\$349.50	10/case

BiTrac MaxShield Select allows for unobstructive view, minimizing claustrophobia

Premiere Contract Pricing Available!



Circuits for Bilevel/CPAP Application

BiTrac™ NIV Circuit (Bilevel/CPAP Applications) 72" Smooth ID Tubing w/ swivel connector w/ exhalation port, cap plug; includes optional 24" tubing w/ "T" and proximal pressure line

Without Filter:	B030874	\$78.00	10/case
With Attached Filter:	B030875	\$80.00	10/case
w/o Filter, non-vented:	B030870	\$78.00	10/case
With Filter, non-vented:	B030871	\$80.00	10/case

Guaranteed Savings!

ValueTrac™ NIV Circuit (Bilevel/CPAP Applications) 72" Corrugated Tubing and swivel connector w/exhalation port and proximal pressure line

B030878	\$70.00
----------------	----------------

TRIGGERNEB NEBULIZER

TriggerNeb™ High Performance "Breath Enhanced" Nebulizer

R

We guarantee savings and superior performance over our competition. Please watch our 1 minute VIDEO:



RESPIRATORY PRODUCTS

TriggerNeb™ Aerosol Nebulizer Performance vs. Competition (Continuous Mode) Test Measurement	Bell Medical, Inc. TriggerNeb™	Monaghan AeroEclipse™ BAN	Salter NebuTech HDN
Particle Size – MMAD (µm)	2.07 ✓	2.8	4.6
Average Treatment Time (min.)	2.58 ✓	5.0	3.24
% Respirable Fraction (% .5–5 µm)	77% ✓	78.4%	51%
Total Respirable Dose (.5 – 5 µg)	818 ✓	791	240
Total Output Rate (µg)	1,058 ✓	1,009	468
Environmental Loss % (Medicine Waste)	4% ✓	4%	>29%

B180440	TriggerNeb™ Reusable Nebulizer Bottle, Supply Tubing & Mouthpiece	50/cs	\$150.00
B180441	Filter with Housing	50/cs	\$26.75
B180441C	Filter with Housing	1,000/cs	\$535.00
B180442	Adult Aerosol Mask & "L" Connector	100/cs	\$106.75
B180443	Child Aerosol Mask & "L" Connector	100/cs	\$106.75
B180444	"L" Connector	100/cs	\$32.00

STETHOSCOPES / TEMPERATURE MONITORING

Chest Pieces

Adult, Large, Wenger™ Weighted Chest Piece

B190046 \$12.50

Pediatric, Small, Wenger™ Weighted Chest Piece

B190045 \$12.50



Lightweight Chest Pieces

Infant Lightweight Chest Piece, 1 1/8" Diameter

B190048 \$11.00

Newborn Lightweight Chest Piece, 7/8" Diameter

B190047 \$11.00

Double Stick™ Adhesive Discs

For chest pieces and electrode attachments.

B190050 100/roll \$16.50



SoftEar™ Disposable Monoscope

The acoustic earpiece enhances transmission of sound by conforming to the ear canal. The SoftEar™ earpiece is more comfortable than the hard plastic earpiece. 4' tubing length.

B190100 25/Box \$66.10
B190102 100/Box \$238.00



Disposable Esophageal Stethoscopes

Heart and breath sounds are easily discerned due to the excellent acoustics inherent in the configuration of the stethoscope. The soft cuff and compliant PVC shaft are designed to minimize trauma during intubation.

Esophageal Stethoscope w/400 Series Temperature

9 French B190240 50/Box \$157.00
12 French B190241 50/Box \$157.00
18 French B190242 50/Box \$157.00
24 French B190243 50/Box \$157.00

Esophageal Stethoscope without Temperature

9 French B190203 50/Box \$97.00
12 French B190200 50/Box \$97.00
18 French B190201 50/Box \$97.00
24 French B190202 50/Box \$97.00

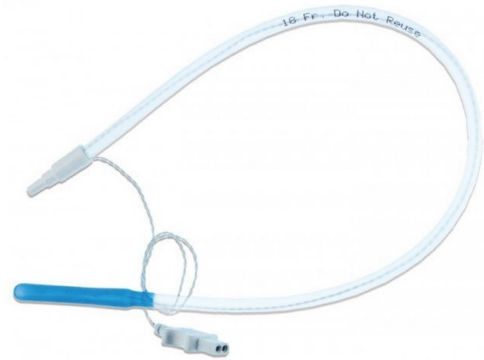

Esophageal Stethoscope Temperature Cables, Reusable



400 Series, Stereo Jack Plug

B190503 \$42.00

Philips / HP Plug

B190505 \$42.00



General Purpose Temperature Probe, Disposable

9 French, 400 Series B190250 50/Box \$150.00
12 French, 400 Series B190251 50/Box \$150.00

Skin Temperature Probe, Disposable

Adult, 400 Series B190259 50/Box \$110.00

Ear Tympanic Temperature Probe, Disp

Adult, 400 Series B190257 50/Box \$157.00

Order Online: www.BellMedical.com customerservice@BellMedical.com

STYLETS

Eschmann Stylet (Bougie) - Reusable

The reusable endotracheal tube introducer and guides are non-sterile and individually packaged.

10 French for 4.0 - 5.5mm tubes, Straight Tip, each	B190510	\$102.00
15 French for 6.0 - 11.0mm tubes, Straight Tip, each	B190513	\$102.00
15 French for 6.0 - 11.0mm tubes, Straight Tip, 5/bx	B190513B	\$491.00
15 French for 6.0 - 11.0mm tubes, Angled Tip, each	B190515	\$111.00
15 French for 6.0 - 11.0mm tubes, Angled Tip, 5/bx	B190515B	\$538.00

Rigid Stylet - Reusable

For 6.0mm tubes and larger, each

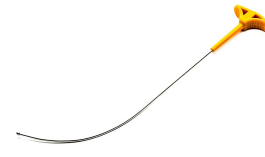

B091902 \$45.00

Eschmann Stylet (Bougie) - Disposable

The disposable endotracheal tube introducers and guides are individually packaged.

15 French for 6.0 - 11.0mm tubes, Angled Tip, Orange
(Clean and ready for patient use)

B091911 **10/box** **\$60.00**

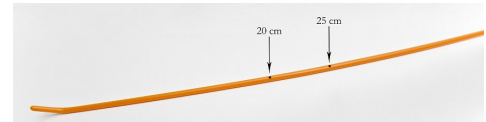

15 French for 6.0 - 11.0mm tubes, Angled Tip, Blue, Sterile

B190525 (straight package) **10/box** **\$75.40**

B190524 Bougie-To-Go **10/box** **\$75.40**



**New package option:
"Bougie-To-Go"**

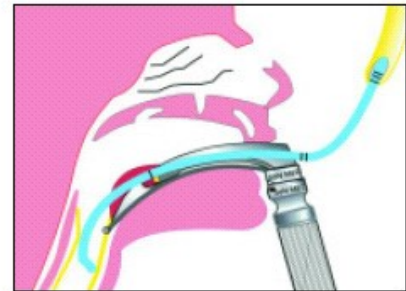
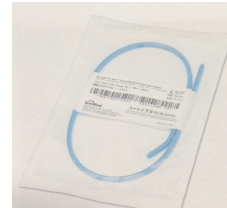

10 French Pediatric, Angled Tip, Blue, Sterile

B190520 **10/box** **\$75.40**



PVC Stylet

Malleable aluminum intubation stylet sealed in a PVC sheath. Latex free, sterile, single use.

10" x 6 French **B190331** **\$63.35 20/box**

11.5" x 10 French **B190332** **\$63.35 20/box**

12.5" x 14 French **B190333** **\$63.35 20/box**



Parker Flex-It™ Directional Stylet

The Parker Flex-It Directional Stylet can be used for oral and nasal intubation and requires no pre-bending. Easy thumb action allows tube curvature to be continuously adjusted during an intubation. Its one-handed operation is designed to facilitate quick, accurate intubation, and it is especially helpful for intubating the most difficult airways.

7.5 - 8.0mm Tubes **B120001** **25/box** **\$85.00**

6.5 - 7.0mm Tubes **B120000** **25/box** **\$85.00**

5.5 - 6.0mm Tubes **B120012** **25/box** **\$85.00**

5.0mm Tubes **B120017** **25/box** **\$85.00**

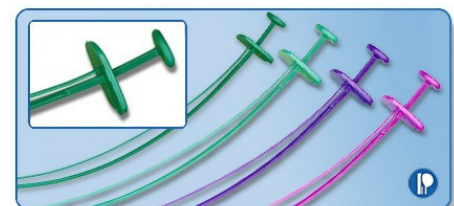

SYRINGE PUMP

OR - INFUSOR ABC Pump 4100

Syringe Infusion Pump for Anesthesia/OR/ICU and NICU

The ABC OR – Infusor is easy to use; allowing users to customize the delivery modes to each patient. The pump comes with fast and easy front syringe and plunger loading. It comes with a cordless power pack that lasts up to 12 hours at 5ml/hr. The warranty is a full one year with free software upgrades. Our new software adds a one button continuous rapid bolus feature!



- Accommodates various syringe manufacturers with automatic size sensing: 1, 3, 5, 10, 20, 30, 60 and 140 ml syringes
- Unique labeling area used to indicate infusion information
- Full alarm capabilities - LED & LCD alerts & audio alarms
- Integrated carrying handle with optional pole mount
- Multiple sensors to monitor delivery accuracy
- Large graphic LCD display for easy viewing
- Simple operation – Easy User customization
Multiple delivery modes (Body-Weight, Mass, Bolus, Continuous, Volume over Time); Adjustable flow rate ranges, changes w/o interrupting flow; Accuracy +/- 3%
- New software offers one button bolus feature that delivers rapid bolus rate of 1,500 mL/hr
- Storage for 90 user defined programmable settings
- Syringe light delineates infusion status from afar
- AC/Battery operated with removable battery pack
- RS232 Interface capabilities

B400230	Syringe Pump	\$3,395
B400231	Rotational Pole Clamp	\$110
B400232	Clone Cable	\$149

One year warranty with free software upgrades!

Order Online: www.BellMedical.com customerservice@BellMedical.com

TEMPERATURE

CliniTemp™ Moving Line Temperature Indicators

CliniTemp™ moving line temperature indicators are fast becoming the preferred alternative to esophageal probes, with more units sold than the largest brand of esophageal probes.

CliniTemp™ moving line temperature indicators are non-invasive, easy to use, highly reliable, and provide precise readings that have been well documented over the years.

CliniTemp™ moving line temperature indicators measure surface temperature and give you a core-adjusted reading on a continuous scale on both Centigrade (29° - 41°C) and Fahrenheit (84° - 106°F).

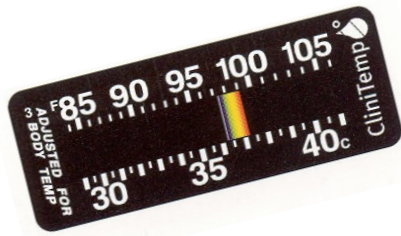

- Accurate to +/- .5°F, 3°C
- Core-adjusted with 3.5°F, 2°C offset

B192000	100/box	\$152.00
B192001	50/box	\$76.00



Esophageal Stethoscope Temperature Cables, Reusable



400 Series, Stereo Jack Plug

B190503 **\$42.00**

Philips / HP Plug

B190505 **\$42.00**



General Purpose Temperature Probe, Disposable

9 French, 400 Series	B190250	50/Box	\$150.00
12 French, 400 Series	B190251	50/Box	\$150.00

Disposable Esophageal Stethoscopes

Heart and breath sounds are easily discerned due to the excellent acoustics inherent in the configuration of the stethoscope. The soft cuff and compliant PVC shaft are designed to minimize trauma during intubation.

Esophageal Stethoscope w/400 Series Temperature

9 French	B190240	50/Box	\$157.00
12 French	B190241	50/Box	\$157.00
18 French	B190242	50/Box	\$157.00
24 French	B190243	50/Box	\$157.00

Esophageal Stethoscope without Temperature

9 French	B190203	50/Box	\$97.00
12 French	B190200	50/Box	\$97.00
18 French	B190201	50/Box	\$97.00
24 French	B190202	50/Box	\$97.00

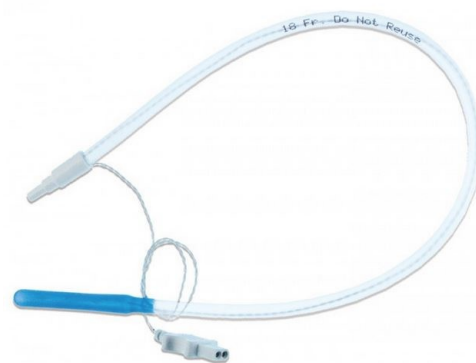

Skin Temperature Probe, Disposable

400 Series **B190259** **50/Box** **\$110.00**

Ear Tympanic Temperature Probe, Disposable

400 Series **B190257** **50/Box** **\$157.00**

ULTRASOUND

Safersonic Sterile Ultrasound Probe Covers



Fits all major ultrasonic probe heads! Designed for nerve blocks. The ultrasound probe is fully covered by the sterile cover. Sterile procedures can start promptly! After procedure, remove the cover as shown, no residual glue remains! Reduces cleaning time, and improves turnover time for next procedure.

The patented adhesive keeps the cover and the probe head together without bubbles or wrinkles improving image quality.

B401530	Continuous Block Ultrasound Probe Cover, 120cm	50/box	\$400.00
B401534	Continuous Block Ultrasound Probe Cover w/Gel	50/box	\$480.00
B401539	Continuous Block, Narrow US Probe Cover w/Gel	50/box	\$480.00
B401531	Single Shot Ultrasound Probe Cover 28cm	50/box	\$300.00
B401536	Single Shot Ultrasound Probe Cover w/Gel, 28cm	50/box	\$380.00
B401533	Medium Ultrasound Probe Cover w/Gel, 50cm	50/box	\$400.00
B401538	Long Ultrasound Probe Cover w/Gel, 250cm	40/box	\$558.00



Watch a short video on
the Safersonic
Ultrasound Probe
Covers



Anesthesia Hygiene Covers

Protect your anesthesia work environment!



Stay clean and organized during contaminated cases.

- Ideal for high-risk patients such as isolation, VRE and MRSA patients
- Disposable organizers cover anesthesia work surfaces and include pockets
- Non-residue adhesive hold cover securely in place
- Fluid repellent
- Tear resistant

Anesthesia Hygiene Organizer Kit*	B401300	50/box	\$1,748
Anesthesia Hygiene Organizer Kit*	B401310	10/box	\$ 388

*Kit includes; Anesthesia Machine cover with organizer pockets, Monitor Cover, Computer Screen Cover, Keyboard and Mouse Covers, Laryngoscope Handle Cover

Work Surface cover with Pockets	B401301	100/box	\$ 496
Monitor Screen Cover	B401302	100/box	\$ 496
Keyboard Cover	B401303	100/box	\$ 67

STYLETVIU VIDEO STYLET

Slim Stylet Video Scope

StyletViu® provides both adult and infant sized video stylet with real time video images, safe reliable and easy to use for endotracheal intubation.



- Lightweight
- Smallest diameter
- Safe design
- Disposable sheath with patent design
- Rotatable Display
- Versatile video output

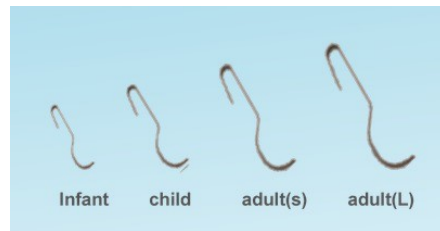
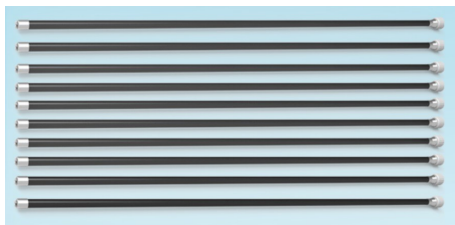

B091930	StyletViu®, Reusable Adult, 4.5 O.D.	\$1,145
B091939	Optional Disposable Adult Sheaths, 6.2mm O.D., 10/box	\$149
B091931	StyletViu®, Reusable Pediatric, 2.2 O.D.	\$2,400
B091939I	Optional Disposable Pediatric Sheaths, 2.9mm O.D., 10/box	\$149

StyletViu® Accessories:

B091938I	Reusable Tongue Anteriorizer, Infant	\$20
B091938C	Reusable Tongue Anteriorizer, Child	\$20
B091938AS	Reusable Tongue Anteriorizer, Adult Small	\$20
B091938AL	Reusable Tongue Anteriorizer, Adult Large	\$20
B091937	Wifi Adapter and Receiver	\$345
B091935	15.6" External Touch Screen Display	\$2,700

BELL MEDICAL SURGICAL DRAPE CLIPS



These high tension surgical drape clips are ideal for supporting sterile drapes to IV poles in the operating room. Our "drape clips" are designed specifically for anesthesia with high tension springs and grip teeth to hold sterile drapes to IV poles.

Order number: B000001

\$98.00 per box of 24

(\$4.08 each - a 30% savings)

Order number: B000002

\$5.85 each

Call **1-800-875-2355** to place an order or purchase online at **www.BellMedical.com**



Back

Bell Medical "Sleep with the Best" T-shirt

B000010	Small	\$12.00
B000011	Medium	\$12.00
B000012	Large	\$12.00
B000013	X-Large	\$12.00
B000014	2X-Large	\$14.00
B000015	3X-Large	\$14.00



Front



Bell Medical
INC.

1728 Macklind Avenue
St. Louis, MO 63110

EyePro Eyelid Occlusion Dressing and NoPress Eye Shield



See page 28

EyePro:

- Easy to apply and remove
- Sterile dressing seals the eye
- Clear window for eye monitoring

NoPress:

- Eliminates pressure on eyes
- Clear view of eyes
- Easy to apply and remove



Call for free samples!

BellMedical.com
800-875-BELL (2355)