

Bell Medical

Anesthesia Products Catalog



CapnoVue/Capnography p15



Nerve Stimulators p61-64



Video Laryngoscopes p33,44



Eye Protection p29



Atomizers p13



Laryngoscopes p39-43



Anesthesia Equipment p52-56



Prone Pillows p66



CO₂ Absorbent p23

Insighters Airway Management System

See page XX



*The Future is
Bright with
Insighters!*

Insighters video display fits Flexible Endoscopes, Rigid Scope and Video Laryngoscope providing a cost effective ONE SYSTEM solution.

Buy the system or order to your needs.

Complete Airway Management System B091990K Includes:

- B091990** Video Laryngoscope, handle
- B091990D** Universal display
- B091998H** Rigid Laryngoscope, handle
- B091999H** Flexible Endoscope, articulating scope
- B091999SH** Flexible Endoscope, articulating scope with channel
- B091999icore** i-Core 2.2mm Flexible Endoscope
- B092900** i-Workstation with wireless module

View a video at BellMedical.com/Insight-Airway-Management-System

Order Online: www.BellMedical.com customerservice@BellMedical.com

CUSTOMER INFORMATION

Bell Medical Guarantee!
Minimum 3% savings compared to any competitors catalog pricing.

Phone: 314-772-5600 or 800-875-2355 Monday through Friday, 8:00 AM to 4:45 PM, CST

Email: Email orders to customerservice@bellmedical.com, please be sure to include:

- Account number (unless using credit card)
- Billing and shipping address
- Purchase order number, if applicable
- Name, email address and telephone number
- Product number and description
- Unit of measure and quantity ordered

Website: www.BellMedical.com

- Order online. Credit card only at this time.

Prices: Subject to change without notice and do not include shipping and handling.

Terms: Net 10 days from date of invoice.

Minimum: No minimum order. A one time \$7.35 handling charge will be added to all orders.

Payment: Check, AMEX, MasterCard or VISA.

Shipping: All orders are F.O.B. St. Louis, Missouri. All freight charges are prepaid and added to invoice.

Merchandise Returns: All returns must be authorized in advance by Bell Medical, Inc. and be assigned a returned goods authorization number (RGA#) based on the following criteria:

- Merchandise must have been purchased within the last thirty (30) days.
- Merchandise must be in original package and in sellable condition.
- Merchandise returned is subject to a 25% restocking fee unless due to defective product, in which case the merchandise will be replaced, or due to shipping error.
- Merchandise returned due to defect is subject to manufacturer's guidelines.
- There is a minimum restocking charge of \$20.00.

Any credit is subject to final acceptance and inspection of product by Bell Medical, Inc.

The following merchandise is not eligible for return unless proven defective:

- Specially ordered items.
- Used merchandise or products not in original shipping containers.
- Merchandise held over thirty (30) days from shipment.
- Merchandise which has been altered or abused in any way.

Product Warranty: Warranty for products sold will be set by the individual manufacturers of these products. The manufacturer's usual warranty period is one (1) year from date of shipment. The exception to this being rubber, plastic and glass components and materials which are warranted to be free from defects at time of delivery.



Anesthesia Machine and BioMed Service

Bell Medical, Inc. has specialized in anesthesia sales and service since 1975. We are an independent service organization trained by Drager, GE Ohmeda, Penlon, and Mindray to service all manufacturers' anesthesia machines. We employ Certified Biomedical Electrical Technicians (CBET's and BMET's) with extensive experience with all anesthesia machines.

We provide comprehensive preventative maintenance for all anesthesia machines regardless of manufacturer. Bell Medical, Inc. uses manufacturer parts for all repairs.

Bell Medical, Inc. offers a comprehensive, fully documented service program, which includes regularly scheduled testing and inspection of the anesthesia machine and related monitors. In addition we provide quarterly Trace Gas Analysis and Room Air Exchange Rate surveys and general biomed service contracts.

Bell Medical, Inc. Service Benefits



Dan Pennington
Service Manager

- Specialist in Anesthesia Machine Service Since 1975
- Service center for Drager, GE, Penlon, and Mindray
- Over 50 years' Experience Servicing Anesthesia Machines
- Over \$100,000 in Parts Inventory
- Full Products and Completed Service Liability Coverage
- Recondition Anesthesia Machine Sales
- Commitment to Quality Service and Total Customer Satisfaction
- Local Ownership and Commitment to the Community
- One Year Warranty on Parts Replaced
- 90-Day Warranty for All Labor Associated with Repairs

Biomedical Services

Bell Medical offers general biomed services for both surgery centers and clinics as well as on-site full management of biomed service for hospitals. We provide service for specialty devices including sterilizers, scope washers, c-arms, gas monitors, lasers, EKG systems, anesthesia units, ventilators, electrosurgical generators, and much more. We have certified field technicians who can provide on-site repair. We offer superior general biomed services for less than the competition.

To receive a quotation, email a copy of your current contract showing machine models, serial numbers, contract type and expiration date to customerservice@bellmedical.com.

Why Buy New?

Bell Medical, Inc. offers preowned and refurbished Mindray, GE and Drager anesthesia machines. We have machines available for sale with full one year warranty. Bell Medical, Inc. will purchase used machines from hospitals and offer trade-in options.

314-772-5600 | 800-875-2355 | CustomerService@BellMedical.com | Fax 314-772-1233

Table of Contents

Bell Medical has a large product selection at www.BellMedical.com.

A	
AIRWAYS, CRICOTHYROTOMY	12
AIRWAYS, NASOPHARYNGEAL	
Adjustable Flange, Disposable, Latex Free.....	9
Naso-Flo Latex Free.....	10
Soft PVC Style, Latex Free.....	9
AIRWAYS, ORAL	
Berman, Color Coded.....	9
Guedel, Soft, Color Coded.....	9
McMurray Airway (MEA).....	10
Williams.....	11
ANESTHESIA MACHINES	52,56
ANESTHESIA MACHINE ACCESSORIES	54-55
ATOMIZERS	
Dart and Dart Reach.....	13
EZ Spray.....	13
B	
BITEME BITE BLOCK	27
BITESAFE DENTAL CUSHION	11
BLOOD PRESSURE MONITOR	
Vital Signs Monitor.....	57
C	
CAPNOGRAPHY	
Capnomask CO2/O2 Monitoring Mask, Aroma.....	14
Capnovue CO2/O2 Monitoring Mask.....	15
Capnoxigen CO2 Monitoring Mask.....	14
CarboTrack.....	16
Comfort Soft Nasal CO2 Cannula.....	16
MicroCap 9 Capnograph/O2 Monitor.....	57
Oridion Microstream Filterlines.....	17-19
PrO2 Mask for ASCs, CO2/O2.....	15
CARTS AND ACCESSORIES	
Anesthesia Carts.....	20-22
Medical Cart Accessories.....	21
CO2 ABSORBENTS	
Amsorb Plus.....	23
D	
DentaSafe Intubation Denatl Guard.....	48
Surgical Drape Clip/Clamp.....	76
E	
EMERGENCY PRODUCTS	
Control-Cric Cricothyrotomy System.....	12
ENDOSCOPY	
Endoscopy Mask.....	19
Insight Flexible Video Endoscope.....	35,38
Insight Flexible Video Endoscope Consumables.....	36
ENDOBONCHIAL TUBES	
Parker Double Lumen Left.....	24
Robertshaw Double Left.....	24
Double Lumen Right.....	24
ENDOTRACHEAL TUBES & ACCESSORIES	
Endotracheal Tubes, Cuffed and Uncuffed.....	25-26
Microlaryngeal.....	25
Preformed RAE, Oral.....	27-28
Preformed RAE, Nasal.....	27-28
Parker Flex-Tip.....	25
Parker Flex-Tip, Easycurve.....	25
Wire Reinforced.....	25
EYE PROTECTION	
EyePro Eyelid Occlusion Dressing.....	29
NoPress Eye Shield.....	29
Saving Eyes, Eye Shield.....	29
F	
Forceps, Magill Intubation.....	26
H	
Head Harnesses.....	19
I	
INFECTION PREVENTION	
Disposable Blades Combination Pkg.....	39-40
Disposable Fiber Optic Blades.....	41
Disposable Green System LED Handles.....	41
Safersonic Ultrasound Probe Covers.....	75
INFUSION & I.V. PRODUCTS	
IV Poles, SmartStack.....	31
PowerMATE IV Pole Power Tap.....	31
Pressure Infusion Bags.....	31
TIVA Total Intravenous Anesthesia.....	30
INTUBATION AIDS	
Control-Cric Cricothyrotomy System.....	12
Eschmann Stylets (Bougie).....	32
Rigid Stylettes.....	32,34,71
Trach Tube X-Changer.....	32
L	
LARYNGEAL MASK AIRWAYS	
Disposable.....	49-51
i-gel Supraglottic Airway.....	50
i-gel Resus Pack.....	50
MRI Compatible.....	51
Reinforced.....	51
Reusable.....	51
LARYNGOSCOPES DISPOSABLE	
Disposable Blades Combination Pkg.....	39-40
Disposable Fiber Optic Blades.....	41
Disposable Fiber Optic Handles.....	41
BriteBlade Pro Blades, Sterile.....	42
BritePro Solo Handles.....	42
Heine Brand.....	43
i-view Video Laryngoscope.....	48
LARYNGOSCOPE BLADES, FIBEROPTIC, REUSABLE	
Bell Medical Macintosh.....	45
Bell Medical Miller.....	45
Heine Brand.....	43
LARYNGOSCOPE HANDLES, FIBEROPTIC, REUSABLE	
Bell Medical LED.....	45
Heine LED.....	43
LARYNGOSCOPE, MRI COMPATIBLE	
MRI Blades, Handles, Reusable.....	46
MRI Blades, Handles, Disposable.....	47
MRI Batteries.....	46-47
LARYNGOSCOPE VIDEO	
Heine visionPRO.....	44
Heine visionPRO Disposable Sheaths.....	44
Insighters Video Airway Management System.....	33-38
Insighters Flexible i-Core Accessoroes.....	35
Insighters Flexible i-Core Scope.....	35
Insighters Rigid Video Laryngoscope.....	37
Insighters Video Laryngoscope.....	34
Insighters Video Laryngoscope Disposable Blades.....	34
i-view Video Laryngoscope.....	48

Table of Contents

Bell Medical has a large product selection at www.BellMedical.com.

N

NEEDLES, REGIONAL ANESTHESIA

Echogenic.....	60
Gertie Marx Spinal.....	59
Gertie Marx Combined Spinal/Epidural.....	59

NERVE STIMULATORS

STIMPOD 450X+.....	61
STIMPOD 450X+ Accessories.....	62
SunStim, SunStim Plus and SunStim Pro.....	64
SunStim Accessories.....	64

O

OXYGEN ADMINISTRATION

Capnomask CO2/O2 Monitoring Mask, Aroma.....	14
Capnovue CO2/O2 Monitoring Mask.....	15
Capnoxigen CO2 Monitoring Mask.....	14
Comfort Soft Nasal CO2 Cannula.....	16
PrO2 Mask for ASCs, CO2/O2.....	15

OXYGEN SENSORS

Anesthesia Machine Oxygen Sensors.....	65
----------------------------------------	----

P

PATIENT MONITORING

MicroCap 9 Capnograph/O2 Monitor.....	57
Mindray Patient Monitor Accessories	54-55
Patient Monitors Bedside.....	53,57
Patient Monitors OR.....	53,57
Vital Signs Monitor.....	57

POSITIONING PAD

Positioning Pads.....	66-67
Tereboot Nerve Block Positioning Device.....	63

PULSE OXIMETERS

Finger Pulse Oximeters.....	68
Handheld Pulse Oximeter.....	68

R

RESPIRATORY THERAPY

Pulmodyne BiTrac NIV Masks and Elbows.....	69
Pulmodyne MAX SHIELD.....	69

S

STETHOSCOPES

Precordial Chest Pieces.....	70
------------------------------	----

STETHOSCOPE ACCESSORIES

Double-stick Adhesive Disc.....	70
Esophageal Stethoscope, Disposable.....	70,73
Monascope, Softear, Disposable.....	70
Temperature Cables.....	70,73

STYLETTES

Eschmann Disposable (Bougie).....	32,71
Eschmann Reusable (Bougie).....	32,71
PVC Coated Stylette.....	71
Rigid Stylettes.....	32,34,71

SURGICAL TABLE.....

.....	58
-------	----

SYRINGE PUMP.....

.....	72
-------	----

T

SURGICAL TABLE.....

.....	58
-------	----

TEMPERATURE MONITORING

CliniTemp Temperature Strips.....	73
Ear (Tympanic) Probes.....	73
Esophageal Stethoscopes.....	70,73
General Purpose Probes.....	70,73
Skin Probes.....	73
Temperature Blankets.....	74
Temperature Cables, Reusable.....	70,73

TOOTH PROTECTION

BiteSafe Dental Cushion.....	11
DentaSafe Intubation Dental Guard.....	48

BELL MEDICAL T-SHIRT.....

.....	76
-------	----

U

ULTRASOUND PROBE COVERS

Safersonic Continuous Block.....	75
Safersonic Single Shot.....	75

V

VIDEO LARYNGOSCOPE

Heine visionPRO and Disposable Sheaths.....	44
Insight Video Airway Management System.....	33-38
Insight Flexible Endoscope.....	38
Insight Rigid Video Laryngoscope.....	37
Insight Video Laryngoscope.....	34
Insight Video Laryngoscope Disposable Blades.....	34

Bell Medical and Bay State Anesthesia merged in 2022 to take advantage of synergies. Together we have over 100 years of experience in anesthesia sales and service. We are a specialty distributor that is dedicated to introducing new technologies that enhance the anesthesia provider's ability to deliver safe patient care. We are headquartered in St. Louis, Missouri and have sales representatives throughout the United States.

Bell Medical is committed to delivering high quality products and the best possible customer service. Thank you for considering the products and services in this catalog and on our website. Your business is appreciated.

Sincerely,



Kevin Lueders
President and CEO



Bell Medical has informational product videos on YouTube.

Order Online: www.BellMedical.com customerservice@BellMedical.com

Find more products online at www.BellMedical.com or call 800-875-BELL (2355).

A

AESTHESIA MACHINE ACCESSORIES

Cast-R-Gard
Cord Caddy

B

BLOOD AND FLUID WARMING

Blood Warmer, Hemokinetitherm
Hemocoils, Disposable

BLOOD PRESSURE CUFFS

Disposable, Cotton, Latex Free
Manual BP Kit
Neonatal
Reusable

BLOOD PRESSURE CUFF ACCESSORIES

Bulbs & Valves
Tubing, Coiled & Straight, Connectors

BLOOD PRESSURE SPHYGMOMANOMETERS

Gauge
Hand Aneroid, Mercurial

BREATHING BAGS

Adult, Pediatric
Disposable, Latex Free, Reusable

BREATHING CIRCUITS

Adult, Pediatric
Expandable
Jackson Rees, Mapleson D
Latex-Free

BREATHING TUBES

Breathing Tube
Gas Evacuation & Scavenging
Ventilator Hose

BREATHING TUBE ACCESSORIES

Gas Sampling Connectors, Filters, Lines
Nafion (Semi-permeable) Tubing
Reservoir for Auxiliary Water Traps
Tube Support

C

CHAIRS

Anesthesia Chair

CONNECTORS & ADAPTERS

Disposable Flex Adapter
Flexible, Racine Universal, Swivel Adapter

CYLINDER CARTS

Multiple D & E Cylinder
Single D & E Cylinder
Single H (Large) Cylinder

E

EMERGENCY PRODUCTS

Abelson Jaw Spreader
Resuscitation Mask
Tracheostomy Kit
Variable PEEP Valve

ENDBRONCHIAL PRODUCTS

Carlens Tube
Dr. White Tube
Robertshaw Tube

ENDOTRACHEAL TUBES & ACCESSORIES

Curved Wire Reinforced
Endotest
Safety Clear Murphy, with Cuff
Safety Clear Murphy, without Cuff

F

FACE MASKS

Ambu Type, Reusable
Anatomical, Reusable
Patil-Syracuse, Reusable
Rendell-Baker Syracuse (RBS), Reusable
Clear Comfort, Disposable

FACE MASK ACCESSORIES

Diaphragm, Replacement for Patil-Syracuse
Head Harness, Black
Hook Ring for Ambu Type Facemask
Williams Airway Intubator, Reusable

FILTERS - BACTERIA/VIRAL

Anesthesia
Gas Sampling Disk

H

HEAT & MOISTURE EXCHANGERS

I

INTUBATION AIDS

Abelson Jaw Spreader
Aillon Tube Bender
Howland Lock
Magill Forceps
Patil Intubation Whistle
Patil-Syracuse Adj. Laryngoscope Handle
Stylette, Infant, Stainless Steel
Tooth Protector

INFUSION & I.V. PRODUCTS

Arterial Cannulation Positioner
Restraint Strap, Soft-Touch, D-Ring
Woods Pump, Rapid Fluid Infusion
Unifusor, Disposable, Pressure Infusion Cuff

J

JET VENTILATION & ACCESSORIES

Copper Tube with Luer Connection
Jet Ventilator System
Wall Adapter Fitting, O2

L

LARYNGOSCOPE ACCESSORIES

Carrying Case
Howland Lock

LARYNGOSCOPES, FIBEROPTIC

Upsher System

LARYNGOSCOPE LAMPS

American Standard, Clear
American Standard, Frosted
FOCS Halogen
Halogen
Upsher Fiber Optic

O

OXYGEN ADMINISTRATION

Oxygen Masks
Oxygen Supply Tubing

OXYGEN MONITORS

Max O2 Analyzer
Max O2 Monitor

P

PEEP VALVES

Reusable, Adjustable, Magnetic Reusable,
Fixed

S

STETHOSCOPES

Disposable
Littman Type
Master Cardiology
Sprague/Rappaport Type

SUCTION

Suction Catheter
Suction Supplies

SUCTION COLLECTION

Carrier, Collection Canisters
Holder, Single Canister
Mounting Kit, Regulator

T

TRACHEOSTOMY TUBES

Cuffed/Uncuffed Tracheostomy Tube
Cuffed and Uncuffed Fenestrated
Extra Length Blue Line
Inner Cannulas

TUBE CHANGERS

Endotracheal Tube Changer
Trach Tube Exchanger
T.T. Tracheal Tube Exchanger

V

VENTILATORS, JET

Copper Tube with Luer Connection
Jet Ventilator
Wall Outlet O2 Adapters

AIRWAYS

Disposable Nasopharyngeal Airway (10/box)



- Latex free
- Single patient use
- Soft PVC
- 10/box

B010612	12 French, 3.0 MM	\$49.60
B010614	14 French, 3.5 MM	\$49.60
B010616	16 French, 4.0 MM	\$49.60
B010618	18 French, 4.5 MM	\$49.60
B010620	20 French, 5.0 MM	\$49.60
B010622	22 French, 5.5 MM	\$49.60
B010624	24 French, 6.0 MM	\$49.60
B010626	26 French, 6.5 MM	\$49.60
B010628	28 French, 7.0 MM	\$49.60
B010630	30 French, 7.5 MM	\$49.60
B010632	32 French, 8.0 MM	\$49.60
B010634	34 French, 8.5 MM	\$49.60
B010636	36 French, 9.0 MM	\$49.60

Disposable Nasopharyngeal Airway with Adjustable Flange (10/box)



- Latex free
- Soft adjustable flange
- Single Patient use
- 10/box

B010712	12 French	\$82.70
B010714	14 French	\$82.70
B010716	16 French	\$82.70
B010718	18 French	\$82.70
B010720	20 French	\$82.70
B010722	22 French	\$82.70
B010724	24 French	\$82.70
B010726	26 French	\$82.70
B010728	28 French	\$82.70
B010730	30 French	\$82.70
B010732	32 French	\$82.70
B010734	34 French	\$82.70
B010736	36 French	\$82.70

Color Coded Guedel Oral Airway (50/bag)



- Latex free plastic
- Color coded for size
- Single use
- Non-sterile
- Individually wrapped
- 50/bag

B010040	40mm, Neonate, Pink	\$58.00
B010050	50mm, Infant, Blue	\$58.00
B010060	60mm, Pediatric, Black	\$58.00
B010070	70mm, Child, White	\$58.00
B010080	80mm, Sm Adult, Green	\$58.00
B010090	90mm, Adult, Yellow	\$58.00
B010000	100mm, Lg Adult, Red	\$58.00
B010011	110mm, Lg Adult, Orange	\$58.00

Berman Airway, Color Coded (50/bag)



- Latex free plastic
- Economical
- Single use
- Non-sterile
- Bulk packages
- 50/bag

B011104	40mm, Neonatal, Pink	\$20.00
B011105	50mm, Infant, Blue	\$20.00
B011106	60mm, Pediatric, Black	\$20.00
B011107	70mm, Child, White	\$20.00
B011108	80mm, Small Adult, Green	\$20.00
B011109	90mm, Adult, Yellow	\$20.00
B011100	100mm, Lg Adult, Lavender	\$20.00
B010211	110mm, X-Lg Adult, Orange	\$31.00

AIRWAYS

McMurray Enhanced Airway (MEA), Disposable (10/box)

McMurray Enhanced (oral) Airway is a distal pharyngeal “oral” airway that is easy to use and is a low cost alternative to high flow nasal systems.



- 2021 World EMS Innovation Award Winner
- Easy oral airway placement reduces nose bleed risk of nasal airways
- Enhances ventilation ability on all patients
- Less chin lifts or jaw thrust maneuvers freeing anesthesia hands
- Deliver positive pressure easily with 15mm connector included
- Ideal for upper GI procedures as MEA fits through side of bite blocks
- Built in bite block and large flange for secure placement and protects patient teeth

B010700 McMurray Enhanced Airway (MEA), Adult \$171.50 10/Box

Naso-Flo® Nasopharyngeal Airway with inline Oxygen and EtCO2, (10/box)

- Oxygen port and elbow allow for direct connection to O2 source
- Soft silicone material designed for less traumatic insertions
- Color-coded elbows aid in correct size selection
- Optional filtered respiratory indicator (CO2 monitor connection)
- Delivers oxygen to the pharynx for higher FiO2 delivery to patient



B011000	4.0MM / 18FR, O2 Port, 15mm Connector	\$81.50
B011001	5.0MM / 22FR, O2 Port, 15mm Connector	\$81.50
B011002	6.0MM / 25FR, O2 Port, 15mm Connector	\$81.50
B011003	7.0MM / 29FR, O2 Port, 15mm Connector	\$81.50
B011004	8.0MM / 32FR, O2 Port, 15mm Connector	\$81.50
B011005	9.0MM / 36FR, O2 Port, 15mm Connector	\$81.50
B011020	4.0MM / 18FR, O2 Port, EtCO2 w/Filter, 15mm Connector	\$125.25
B011021	5.0MM / 22FR, O2 Port, EtCO2 w/Filter, 15mm Connector	\$125.25
B011022	6.0MM / 25FR, O2 Port, EtCO2 w/Filter, 15mm Connector	\$125.25
B011023	7.0MM / 29FR, O2 Port, EtCO2 w/Filter, 15mm Connector	\$125.25
B011024	8.0MM / 32FR, O2 Port, EtCO2 w/Filter, 15mm Connector	\$125.25
B011025	9.0MM / 36FR, O2 Port, EtCO2 w/Filter, 15mm Connector	\$125.25
B011046	4.0MM / 18FR, O2 Port, MSA EtCO2 w/Filter, 15mm, Adj. Flang	\$161.50
B011047	5.0MM / 22FR, O2 Port, MSA EtCO2 w/Filter, 15mm, Adj. Flange	\$161.50
B011048	6.0MM / 25FR, O2 Port, MSA EtCO2 w/Filter, 15mm, Adj. Flange	\$161.50
B011049	7.0MM / 29FR, O2 Port, MSA EtCO2 w/Filter, 15mm, Adj. Flange	\$161.50

AIRWAYS

Williams Airway, Disposable (10/bag)

The airway intubator is cylindrical on the proximal half and open on the distal half of the lingual surface. The airway intubator is indicated for use as an oral pharyngeal airway, a means of intubating the trachea, and a guide for fiberoptic laryngoscope placement.

B120015	9cm for use with up to 7.5ID endotracheal tube	\$64.75
B120016	10cm for use with up to 8.5ID endotracheal tube	\$64.75



BiteSafe: Dental Cushion for Berman, Guedel and Williams Airways



BiteSafe is a universal airway dental cushion that helps prevent dental and oral trauma to patients.

BiteSafe will work with your current airways!

- Significantly reduces dental trauma
- Provides a cushioned area for teeth
- Fits all Guedel or Berman oral airways
- Proprietary foam cube with internal cut-out
- Seamless integration into current anesthesiology practices
- Average tooth repair cost is \$2,500
- Single use, latex free, made in USA

Stop risking dental damage with hard oral airways. Choose BiteSafe!

B122000	BiteSafe, Universal Dental Cushion	\$18.00 10/box
B122001	BiteSafe, Universal Dental Cushion	\$84.00 50/box

AIRWAYS - CRICOTHYROTOMY

A

AIRWAYS - CRICOTHYROTOMY

Control-Cric™ Cricothyrotomy System

The Control-Cric System is a simplified surgical approach to a cricothyrotomy that helps to maintain control during a high-stress situation. The Control-Cric has a 10mm long dual sided blade with an integrated sliding trach-hook. The Control-Cric has a pre-shaped stylet that provides airway confirmation with tactile feel of the tracheal rings, along with a 5.5mm ID soft silicone cric-tube with cuff.

- Easy to use!
- 5 Year Shelf Life!
- Cost Effective!
- Saves Lives!



Sliding Tracheal Hook slides over the dual sided blade and into the incision site to help you maintain your airway.

Look for the Control-Cric Video



B080320	Control-Cric System	\$216 Each*
B080320B	Control-Cric System	\$1,164 5/Box*
B080329	Training Control-Cric	\$150 Each†
B080329B	Training Control-Cric	\$1,240 10/Box†

*Sterile, †Non-Sterile

Bell Medical, Inc. 314-772-5600 800-875-BELL (2355)

12

ATOMIZERS

DART, DART-Reach, and EZ Spray



Dart



Dart Reach



EZ Spray

DART provides safe, painless intra-nasal medication delivery.

DART-Reach delivers medications to the upper airway and beyond the vocal cords.

EZ-Spray is a powered atomizer designed for rapid anesthetization of patient's airway. Single patient use, closed system, preventing the possibility of cross-contamination. Connects to oxygen source at 7-10 LPM according to desired flow rate. 180° directional tip provides direct delivery of medication to the upper pharynx.

Why pay more for MAD? Get DART!

Bell#	Teleflex#	Single Patient Use Atomizers		
B060450	MAD600	DART-Reach (8 inches) 5 mL syringe	\$192.50	25/bx
B060451	MAD700	DART-Reach (8 inches) without 5 mL syringe	\$175.00	25/bx
B060452	MAD720	DART-Reach (4 inches) without 5 mL syringe	\$175.00	25/bx
B060460	MAD300	DART Nasal without syringe	\$110.40	25/bx
B060461	MAD110	DART Nasal 1 mL syringe	\$107.00	25/bx
B060462	MAD100	DART Nasal 3 ml syringe	\$113.00	25/bx
B060463	MAD140	DART Nasal with 3ml Syringe and Vial Adaptor	\$134.00	25/bx
B060464		60cc Power Atomizer with Trigger	\$252.30	10/bx
B060465	MAD500	15cc Power Atomizer with Trigger	\$252.30	10/bx
B060466		15cc Power Atomizer for ENT	\$192.30	10/bx

Call for a free sample!

CAPNOGRAPHY



Capnomask™ O₂/CO₂ Mask with Aromatherapy, (50/box)

The Capnomask™ is ideal for monitored anesthesia cases (MAC) and for use in the PACU. Capnomask™ provides oxygenation while safely monitoring capnography.

- Vanilla scented to help reduce nausea and vomiting
- Capnomask™ is latex free
- Soft transparent DEHP free PVC
- Nose clip and elastic straps for easy adjustment
- O₂ line and CO₂ monitor line pre-attached for speedy hook-up
- 0.22 micron filter to reduce risk of cross contamination and infection

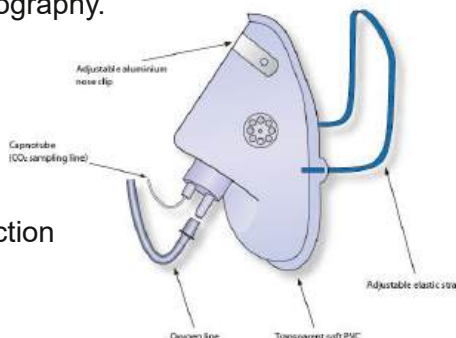

Capnomask™ Includes: O₂ mask, 7' O₂ tubing, 10' MxM CO₂ sample line with filter

B180155	Adult mask, O₂/CO₂	\$250.40
B180159	Adult mask, Microstream Compatible, O₂/CO₂	\$495.00
B180151	Ophthalmic mask, O₂/CO₂	\$250.40
B180158	Ophthalmic mask, Microstream Compatible, O₂/CO₂	\$495.00
B180152	Pediatric mask, O₂/CO₂	\$250.40
B180156	Pediatric mask, Microstream Compatible, O₂/CO₂	\$495.00

Vanilla scented!



Capnoxxygen O₂/CO₂ Sampling Mask, (25/box)

A consistent means to monitor breathing on non-intubated patients. The CAPNOXYGEN™ mask incorporates a bevel tip sample tube in the mid dome of a medium concentration oxygen mask. Simply connect the male end of the sample line from any sidestream CO₂ sample system to the female luer connector on the CAPNOXYGEN™ mask.



B180050	Adult CAPNOXYGEN™	\$130.00
B180052	Pediatric CAPNOXYGEN™	\$126.00

Adult CAPNOXYGEN™ Mask w/8' Sample Line	B180055	\$163.00
Pediatric CAPNOXYGEN™ Mask w/8' Sample Line	B180056	\$153.00

Adult CAPNOXYGEN™ Mask w/14' Sample Line	B180054	\$182.00
-------------------------------------------------	----------------	-----------------

CAPNOGRAPHY

CapnoVue® Scope Oxygen and Capnography Mask, 50/case

- GI, Cardiology and Pulmonary prefer CapnoVue SCOPE's direct alignment to mouth.
- Designed for high FiO₂ and easy endoscope access for upper airway procedures
- Measures capnography reliably and accurately even at high oxygen flows
- Bilateral CO₂ sampling ports effective sampling for mouth breathers on upper GI cases
- FDA-cleared for upper airway procedures, Latex and DEHP free



CapnoVue Scope O₂/CO₂ Face Mask with Scope Access:

B180165S	CapnoVue SCOPE, 7' O₂ tubing	\$398.50
B180167S	CapnoVue SCOPE, 7' MxM Sample Line, 7' O₂ tubing	\$440.00
B180167SL	CapnoVue SCOPE, 15' MxM Sample Line, 14' O₂ tubing	\$440.00
B180168S	CapnoVue SCOPE, 10' MxF Sample Line, 7' O₂ tubing	\$440.00
B180166S	CapnoVue SCOPE, 13' MSA Microstream Sample Line, 14' O₂ tubing	\$659.00
B180165PS	CapnoVue SCOPE, Pediatric, 7' O₂ tubing	\$407.00
B180167PS	CapnoVue SCOPE, Pediatric, 10' MxM SL, 7' O₂ tubing	\$440.00
B180168PS	CapnoVue SCOPE, Pediatric, 10' MxF SL, 7' O₂ tubing	\$440.00
B180166PS	CapnoVue SCOPE, Pediatric, 13' MSA* SL, 7' O₂ tubing	\$659.00

Upper GI Mask POM Alternative: PrO₂ Mask for ASCs, 30/case

The new PrO₂ Mask is an Upper GI Endoscopy Oxygen Mask that provides scope access and high patient FiO₂ and EtCO₂ monitoring.

- **Oral Access Port:** Allows introduction of endoscopes for Upper GI procedures
- **Nasal Access Port:** Facilitates nasal intubations and bronchoscopy
- **Capnography Port:** Standard luer at the mask with male, female, or MicroStream monitor connections
- **Oxygen Port:** Accepts medium concentration elbow or high concentration reservoir bag



B180160T	1001-MM	7' oxygen tubing & reservoir bag, MxM CO₂ sample line	\$289
B180161T	1001-MF	7' oxygen tubing & reservoir bag, MxF CO₂ sample line	\$266
B180163T	1001-MSA	7' oxygen tubing & reservoir bag, Microstream CO₂ Line	\$457
B180165T	1003	7' oxygen tubing, female luer mask connector	\$256
B180166T	1003-MSA	Microstream CO₂ sample line, 7' oxygen tubing	\$423
B180167T	1003-MM	MxM CO₂ sample line, 7' oxygen tubing	\$283
B180168T	1003-MF	MxF CO₂ sample line, 7' oxygen tubing	\$283

Order Online: www.BellMedical.com customerservice@BellMedical.com

CAPNOGRAPHY

Comfort Soft Nasal Cannulas for CO₂ Monitoring and O₂ Delivery

Split cannula provides high quality EtCO₂ sampling from one nare and oxygen delivery from the other nare with less dilution of CO₂ sample.



Comfort Soft Plus Cannulas, , Male Luer and Female connector option included.

B180030	Adult 10' O₂ and CO₂ Lines	\$61.00	25/box
B180030C	Adult 10' O₂ and CO₂ Lines	\$243.00	100/box
B180032C	Adult, 14' O₂ and CO₂ Lines	\$274.00	100/box
B180035	Pediatric 7' O₂ and CO₂ Lines, Male luer	\$140.00	25/box

Bell Medical Guarantee!
Minimum 3% savings compared to any competitors catalog pricing.

CarboTrack CO₂ Airway Adapter

- Improved end-tidal CO₂ tracking under moderate and deep sedation
- Adapts to most airways, facemasks, and cannulas to provide simultaneous EtCO₂ sampling
- Features CO₂ sample line port, nasal cannula docking ports, and medical-grade adhesive



New!

B110020
\$45.00 10/box

CAPNOGRAPHY

Medtronic/Philips Oridion Microstream Compatible Capnography

Bell Medical Oridion Microstream compatible capnography supplies are designed to work with Oridion Microstream enabled monitors.



Procedural Sedation – GI, Cath/EP Lab, IR, ED

O2/CO2 Oral/Nasal 7' Capnography Line Plus with Filter and 7' O2 Tubing, 25/box

B203325R	Adult with Oral Scoop(009822)	\$236
B203325RL	Adult with Oral Scoop, 14' Long (009826)	\$246
B203068R	Pediatric w/Oral Scoop(007269)	\$224



O2/CO2 Nasal 7' Capnography Line with Filter and 7' O2 Tubing, 25/box

B203311RL	Adult Dual Sampling, 14" Long (007739)	\$199
B203311RS	Adult w/Split Cannula (006912)	\$181
B203310RS	Pediatric w/Spilt Cannula(006913)	\$189



Intubated Patient Application

Adult/Pediatric Intubated Airway Set
7' Capnography Line Filter (XS-04620)

B203316R		\$173
----------	--	-------

Bell Medical Guarantee!
Minimum 3% savings compared to any competitors catalog pricing.

CAPNOGRAPHY



Medtronic/Philips Oridion Microstream Capnography Solutions

Procedural Sedation - GI, Cath/EP Lab, IR, ED

Smart CapnoLine® Plus with O2 Male Connector, Adult, 009818	B203327	\$297 / 25
Smart CapnoLine® Plus with O2 Male Connector, Adult, 010209	B203331	\$1,188 / 100
Smart CapnoLine® Plus with O2 Male Connector, Pediatric, 007266	B203320	\$318 / 25
Smart CapnoLine® Plus with O2 Tubing, Adult, 009822	B203325	\$337 / 25
Smart CapnoLine® Plus with O2 Tubing, Adult, 010210	B203332	\$1,348 / 100
Smart CapnoLine® Plus with O2 Tubing, Long 14' Adult, 009826	B203326	\$395 / 25
Smart CapnoLine® Plus with O2 Tubing, Long 14' Adult, 010341	B203330	\$1,580 / 100
Smart CapnoLine® Plus with O2 Tubing, Pediatric, 007269	B203068	\$353 / 25
Smart CapnoLine® Plus with O2 Tubing, Long 14' Pediatric, 007743	B203329	\$428 / 25



Smart CapnoLine Plus



Nasal Only Sampling

Nasal Only Sampling with O2 Tubing, Adult, 006912	B203311	\$270 / 25
Nasal Only Sampling with O2 Tubing, Adult, 010304	B203504	\$1,078 / 100
Nasal Only Sampling with O2 Tubing, Long 14' Adult, 007739	B203312	\$297 / 25
Nasal Only Sampling with O2 Tubing, Long 14' Adult, 010344	B203359	\$1,188 / 100
Nasal Only Sampling with O2 Tubing, Pediatric, 006913	B203310	\$342 / 25
Nasal Only Sampling with O2 Tubing, Infant/Neonatal, XS04476	B203309	\$386 / 25

Smart CapnoLine Guardian

with male ended O2 connector, 012528	B203350	\$438 / 25
with male ended O2 connector, 012537	B203340	\$1,752 / 100
with 7ft/2m O2 tubing, 012529	B203351	\$478 / 25
with 7ft/2m O2 tubing, 012538	B203341	\$1,912 / 100
14' long, w/ 7ft/2m O2 tubing, 012530	B203346	\$492.00 / 25
14' long, w/7ft/2m O2 tubing, 012539	B203343	\$1,968.00 / 100



Smart OmniLine™ Guardian (use with all non-Oridion monitors)

Smart OmniLine Guardian, 6.5' O2 Tubing, 012531	B203356	\$478 / 25
Smart OmniLine Guardian, 13' with O2 Tubing, 012532	B203357	\$492 / 25

Patient Controlled Analgesia (PCA) Applications

Smart CapnoLine® H Plus O2, Adult, 010433	B203069	\$470 / 25
Smart CapnoLine® H Plus O2, Adult, 010625	B203339	\$1,880 / 100
Smart CapnoLine® H Plus O2, Pediatric, 010582	B203369	\$512.50 / 25
Smart CapnoLine® H Plus O2, Pediatric Long, 012464	B203387	\$553.50 / 25



CAPNOGRAPHY

Medtronic/Philips Oridion Microstream Capnography Solutions

Intubated Patient Application

FilterLine® H (Long Term) Set

Adult/Pediatric, 7' Sample Line, XS-04624	B203314	\$376.50 / 25
Adult/Pediatric, 7' Sample Line, 010580	B203380	\$1,506 / 100
Infant/Neonate, 7' Sample Line, 006324	B203315	\$377.50 / 25
Long Adult/Pediatric, 14' Sample Line, 007737	B203317	\$479.00 / 25



FilterLine® Set

Adult/Pediatric, 7' Sample Line, XS-04620	B203316	\$295.50 / 25
Adult/Pediatric 7' Sample Line, 010579	B203381	\$1,182 / 100
Long Adult/Pediatric 14' Sample Line, 007768	B203323	\$337.50 / 25



Disposable "Positive Pressure" Endoscopy Mask

- Fiberoptic Intubation. ET tube can follow along the bronchoscope orally or nasally through the flexible membrane. After intubation the membrane is pushed inside which allows easy removal of the mask.
- Membrane guarantees an ideal seal and efficient ventilation before, after bronchoscopy without time pressure.
- Gastroenterology
- Trans Esophageal Echocardiography, TEE



B100651	Size 1, Infant, 2mm Hole Membrane	\$301.50 6/box
B100652	Size 3, Child, 3mm Hole Membrane	\$301.50 6/box
B100654	Size 5, Adult, 5mm Hole Membrane	\$301.50 6/box

For Gastroenterology and Trans Esophageal Echocardiography:

B100653	Size 3, Child, 5mm Hole Membrane	\$301.50 6/box
B100655	Size 5, Adult, 10mm Hole Membrane	\$301.50 6/box

Disposable Hook Ring for Endoscopy Masks

B100659	\$22.60	10/box
----------------	----------------	---------------



Disposable Head Harness for Anesthesia or Endoscopy Masks

B100715	\$180.00	50/box
----------------	-----------------	---------------

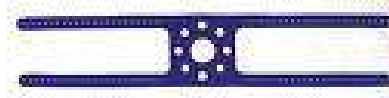

Reusable Head Harness for Anesthesia or Endoscopy Masks

B100700	Adult	\$29.00	each
B100701	Child	\$30.50	each
B100702	Pediatric	\$82.00	each



CARTS

C

CARTS

Anesthesia Cart with Ultimate Accessory Package

Push Button Lock, Six (6) Drawers (3 x 3", 2 x 6", 1 x 9"), Ball Bearing Full Extension Slides, 5" Swivel Caster (Two Locking), Plastic Top



Accessory Package includes: Trellis system, 5 Tilt bin x 2, Tape dispenser, Heavy-duty railing, Divided organizer with lid, Catheter holder, Accessory bar brackets, Tray with dividers and ample holders, Utility hooks, 3" Tray x 4 w/dividers, 5" Tray x 2 w/dividers, Label holders, 12 per pkg., Wire basket, Waste container

Specify color.

B040000 (Steel Cart) \$4,350

Anesthesia Cart Basic

Key Lock, Six (6) Drawers (3 x 3", 2 x 6", 1 x 9"), Ball Bearing Full Extension Slides, 5" Swivel Caster (Two Locking), Plastic Top.

Specify color.

B040001 (Steel Cart) \$2,175

B040001A (Aluminum Cart) \$2,295



14 Standard Colors: Red, Slate Blue, Yellow, Lavender, Mauve, Sea Foam Green, Deep Blue, Taupe, Teal, Beige, Crash Cart Blue, Cranberry, Blue Gray, Hunter Green

Don't see what you are looking for here? Contact us for full cart catalog. Many additional cart configurations available!

CARTS

Malignant Hyperthermia Cart

The Waterloo Malignant Hyperthermia Cart with ACCUCOLD 1 cu. ft. interior refrigerator. Temperature alarm sounds if the unit's interior goes out of range.

- ACCUCOLD 1 cu. ft. interior refrigerator with external microprocessor temperature controller and temperature alarm
- Intelligent microprocessor digital temperature controller
- Adjustable operating control range from +2°C to +10°C
- Digital display of the temperature in C or F
- Audible/visual alarms for high/low temperature excursions
- Key lock front door and hospital grade plug standard
- 115 VAC/60 HZ
- User Replaceable refrigerator!



Assembled Dimensions: 29" wide x 24.5" deep x 45" high

NOTE: Must order both part numbers to build a hyperthermia cart

B040109 Malignant Hyperthermia Cart Shell only	\$2,750
B040110 Malignant Hyperthermia Cart Refrigerator only	\$2,270

Cart Accessories

B040306	Oxygen tank holder for D/E size cylinder	\$74.00
B040308	Tape and label dispenser for cart or table top	\$140.00
B040307	Catheter container, clear front, 19" x 8" x 4"	\$168.00
B130101H	Introducer/Bougie Holder	\$40.00
B040317	28 qt Waste Container includes mounting bracket (not rail).	\$70.00
B040305	Six (6) receptacle outlet strip. Hospital grade with 15' cord	\$242.00
B040313	IV bag pole to fit anesthesia cart, 2 pronged, telescopes 13" - 36"	\$188.00

Full Drawer Tray W x 15 1/2" D x 2 5/16" H options:

B040303	8 Dividers, 14 Ampule Holders, 2 Rails	\$309.00
B040304	6 Dividers, 2 Rails for 6", 9" and 12" Drawers	\$318.00
B040310	7 Dividers, 18 Ampule Holders	\$290.00

Wide range of accessories available, call 1-800-875-2355 for information.

CARTS

MetroCarts



Anesthesia & Emergency Cart



Crash Cart

- Easy to clean Microban Antimicrobial technology infused in polymer inhibiting growth of microorganisms and the spread of infections.
- Non-metal polymer material eliminates rust or paint chipping that occurs with metal carts
- Light weight and easy to move with built in grip areas for easier control
- Tracking casters enhance steering plus total lock casters help keep cart stable when needed
- Ergonomically designed with users in mind
- Total customization with multiple attachments and accessories available to meet all needs
- Electronic security system options for medication controls
- Metro offers metal, aluminum or polymer carts.

Basix carts can be equipped with electronic touchpads and proximity card readers supporting 500 users.

Starsys carts can be equipped with electronic touchpads and optional proximity card readers with user count up to 3000 and add optional management software, audit trails, and wireless updating capabilities.

Flexline carts have the highest level of security technology. They feature touchpads with LCD screens, motion sensing, and up to 6000 users. Flexline carts can be equipped with up to 3 electronically controlled, double-locking narcotics (or Controlled Substance) drawers for the ultimate in anesthesia medication control and monitoring.

**Bell Medical can configure any cart to fit your needs.
Contact us for more information or a quotation.**

CO₂ ABSORBENT

Amsorb® Plus Carbon Dioxide Absorbent

Amsorb® Plus is a new generation carbon dioxide absorbent, free from strong alkali metal hydroxides with **NO Sodium Hydroxide**, specifically designed for low and minimal flow anesthesia. Amsorb® Plus is the safest absorbent available with these advantages:

- No Toxic byproducts, No Compound A, No Carbon Monoxide, No Formaldehyde
- APSF, Anesthesia Patient Safety Foundation recognized, 2005
- Mannion 2011 ASA Amsorb Plus Study: 25.7% Annual Anesthetic Gas Savings, 59% reduction in product usage, 83% Savings in disposal cost of non-toxic spent absorbent
- No heat or fire hazard, No degradation of anesthetic agents
- PERMANENT COLOR CHANGE
- Safe for disposal in standard waste with low pH

Read the Mannion 2011 ASA Study 

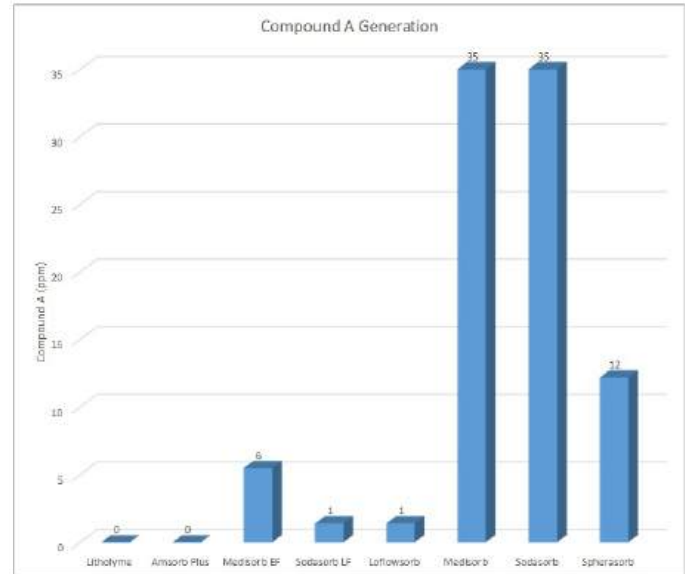
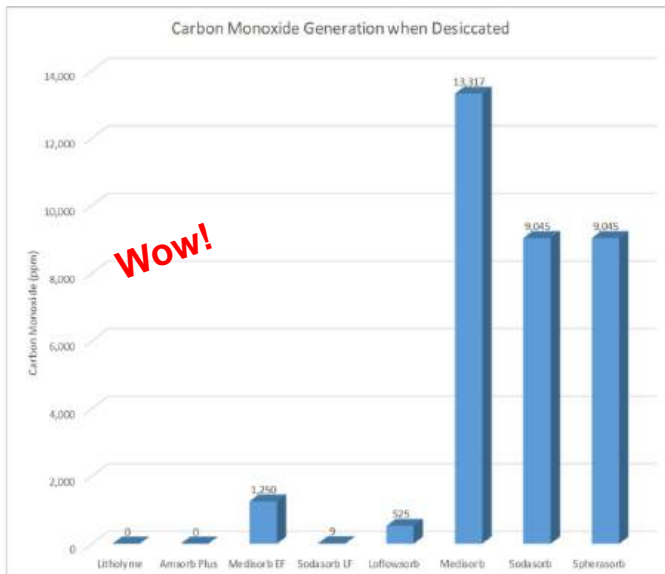

B050010	1 Kg Pre-pak Cartridge, (Aestiva, Mindray)	12/case	\$166.00
B050011	1 Kg Bags	12/case	\$156.00
B050013	Jerican, 5 liter	2/case	\$ 82.50
B0500148	GE (Aespire, Avance, Aisys)	8/case	\$156.00
B050015	Drager (Fabius GS, Draeger Clic)	6/case	\$129.00
B050019S	GE (Carestation 600)	6/case	\$196.25
B050038	Getinge (formerly Maquet)	6/case	\$218.75



B0500148



B050010



B050019S



B050015

Call for contract pricing. Price match Guarantee!

Order Online: www.BellMedical.com customerservice@BellMedical.com

ENDOBONCHIAL TUBES

Parker Double Lumen Endobronchial Tube, Left

The Parker “No Clamp needed” Double Lumen Endobronchial Tube for the left side is constructed to help make anesthesia easier and more efficient. The Endobronchial Tube has a Y-connector with stopcock type valves to quickly and easily open or close each lung to ventilation.

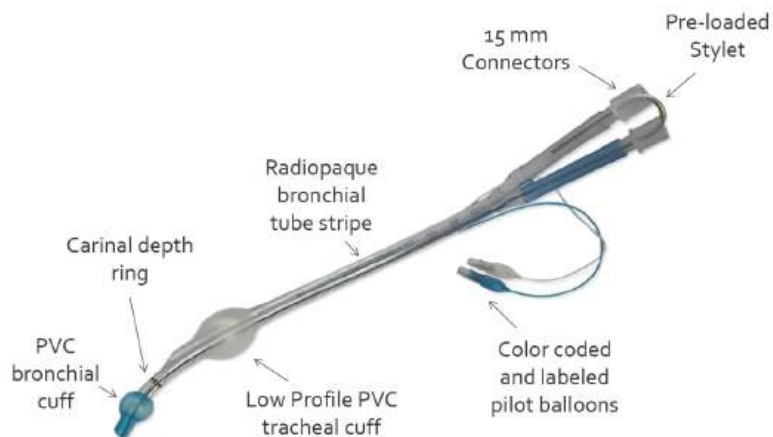

- Pre-assembled Y-connector for expediency
- 90 degree ball-valve eliminate needs for awkward clamps
- Scope and Suction catheter access in either “On” or “off” position
- Easy thread, low friction suction catheters

B090150	28 Fr	\$85.00 Each
B090151	32 Fr	\$85.00 Each
B090152	35 Fr	\$85.00 Each
B090153	37 Fr	\$85.00 Each
B090154	39 Fr	\$85.00 Each
B090155	41 Fr	\$85.00 Each

CALL FOR FREE SAMPLE!

Robertshaw Double Lumen Endobronchial Tube, Left

- Color coded clear and blue for easy differentiation of appropriate lumen, pilot balloon and cuff
- Soft PVC
- High volume, low pressure cuff
- Radiopaque strip
- Graduated depth marks
- Suction catheter included
- Bronchial stylette included
- Y 15mm connector included with each tube



B090035	35 Fr	\$110.00 Each
B090037	37 Fr	\$110.00 Each
B090039	39 Fr	\$110.00 Each
B090041	41 Fr	\$110.00 Each

Double Lumen Endobronchial Tube, Right

- Color coded clear and blue for easy differentiation of appropriate lumen, pilot balloon and cuff
- Soft PVC
- High volume, low pressure cuff
- Radiopaque strip
- Graduated depth marks
- Suction catheter included
- Bronchial stylette included
- Y 15mm connector included with each tube

B090235	35 Fr	\$121.00 Each
B090237	37 Fr	\$121.00 Each
B090239	39 Fr	\$121.00 Each
B090241	41 Fr	\$121.00 Each



ENDOTRACHEAL TUBE - ET TUBES

Parker Flex-Tip™ Endotracheal Tubes



The patented Parker Flex-Tip Tracheal Tube has a soft, flexible, curved, centered, distal tip that is designed to prevent trauma. This tip, which is flanked by double Murphy eyes, flexes and yields as it is advanced into contact with airway anatomy. The centered tip tends to move along the midline of the airway and the glottic opening. The tip's curvature predisposes it to "ski" gently along airway surfaces.

Parker Flex-Tip™ ET Tube, Cuffed

B092040	Size 4.0mm	10/box	\$45.00
B092045	Size 4.5mm	10/box	\$45.00
B092050	Size 5.0mm	10/box	\$45.00
B092055	Size 5.5mm	10/box	\$45.00
B092060	Size 6.0mm	10/box	\$45.00
B092065	Size 6.5mm	10/box	\$45.00
B092070	Size 7.0mm	10/box	\$45.00
B092075	Size 7.5mm	10/box	\$45.00
B092080	Size 8.0mm	10/box	\$45.00
B092085	Size 8.5mm	10/box	\$45.00
B092090	Size 9.0mm	10/box	\$45.00
B092095	Size 9.5mm	10/box	\$45.00

Parker Flex-Tip™ ET Tube, Uncuffed

B091525	Size 2.5mm	10/box	\$45.00
B091530	Size 3.0mm	10/box	\$45.00
B091535	Size 3.5mm	10/box	\$45.00
B091540	Size 4.0mm	10/box	\$45.00
B091545	Size 4.5mm	10/box	\$45.00
B091550	Size 5.0mm	10/box	\$45.00
B091555	Size 5.5mm	10/box	\$45.00
B091560	Size 6.0mm	10/box	\$45.00
B091565	Size 6.5mm	10/box	\$45.00
B091570	Size 7.0mm	10/box	\$45.00

Parker Flex-Tip™ ET Tube, Reinforced, Cuffed

B091755	Size 5.5mm	5/box	\$154.90
B091760	Size 6.0mm	5/box	\$154.90
B091765	Size 6.5mm	5/box	\$154.90
B091770	Size 7.0mm	5/box	\$154.90
B091775	Size 7.5mm	5/box	\$154.90
B091780	Size 8.0mm	5/box	\$154.90
B091785	Size 8.5mm	5/box	\$154.90
B091790	Size 9.0mm	5/box	\$154.90
B091795	Size 9.5mm	5/box	\$154.90

Parker Flex-Tip™ ET Tube, Reinforced, Uncuffed

B091630	Size 3.0mm	5/box	\$154.90
B091635	Size 3.5mm	5/box	\$154.90
B091640	Size 4.0mm	5/box	\$154.90
B091645	Size 4.5mm	5/box	\$154.90
B091650	Size 5.0mm	5/box	\$154.90
B091655	Size 5.5mm	5/box	\$154.90
B091660	Size 6.0mm	5/box	\$154.90

Parker Flex-Tip™ ET Tube, Easycurve, Articulating, Cuffed

B092015	Size 5.0mm	10/box	\$90.25
B092016	Size 6.0mm	10/box	\$90.25
B092017	Size 7.0mm	10/box	\$90.25
B092018	Size 8.0mm	10/box	\$90.25

Parker Flex-Tip™ ET Tube, Microlaryngeal (MLT), Cuffed

B092600	Size 4.0mm	10/box	\$121.25
B092601	Size 5.0mm	10/box	\$121.25
B092602	Size 6.0mm	10/box	\$121.25

ENDOTRACHEAL TUBES - ET TUBES

High volume/low pressure cuff is designed to equalize and reduce pressure against tracheal tissue, assuring excellent seal. Sterile and latex free.

EndoTube Endotracheal Tube, Cuffed, Murphy Eye



B092300	Size 3.0mm	10/box	\$18.00
B092301	Size 3.5mm	10/box	\$18.00
B092302	Size 4.0mm	10/box	\$18.00
B092303	Size 4.5mm	10/box	\$18.00
B092304	Size 5.0mm	10/box	\$18.00
B092305	Size 5.5mm	10/box	\$18.00
B092306	Size 6.0mm	10/box	\$18.00
B092307	Size 6.5mm	10/box	\$18.00
B092308	Size 7.0mm	10/box	\$18.00
B092309	Size 7.5mm	10/box	\$18.00
B092310	Size 8.0mm	10/box	\$18.00
B092311	Size 8.5mm	10/box	\$18.00

EndoTube Endotracheal Tube, Uncuffed, Murphy Eye



B092313	Size 3.0mm	10/box	\$12.00
B092314	Size 3.5mm	10/box	\$12.00
B092315	Size 4.0mm	10/box	\$12.00
B092316	Size 4.5mm	10/box	\$12.00
B092317	Size 5.0mm	10/box	\$12.00
B092318	Size 5.5mm	10/box	\$12.00
B092319	Size 6.0mm	10/box	\$12.00

Bell Medical Guarantee!
Minimum 3% savings compared to any competitors catalog pricing.

Magill Intubation Forceps

- Surgical stainless steel

B120000	Open Tip, Adult 5.5"	\$35.00
B120001	Open Tip, Child 4.5"	\$35.00



B120003	Closed Tip, Adult 5"	\$35.00
B120004	Closed Tip, Child 4"	\$35.00
B120005	Closed Tip, Infant 3"	\$35.00



SPECIALTY ENDOTRACHEAL TUBES

Parker Flex-Tip™ ET Tube, Preformed Nasal, Cuffed

B091295	Size 4.0mm	5/box	\$32.50
B091296	Size 4.5mm	5/box	\$32.50
B091297	Size 5.0mm	5/box	\$32.50
B091298	Size 5.5mm	5/box	\$32.50
B091290	Size 6.0mm	5/box	\$32.50
B091291	Size 6.5mm	5/box	\$32.50
B091292	Size 7.0mm	5/box	\$32.50
B091293	Size 7.5mm	5/box	\$32.50
B091294	Size 8.0mm	5/box	\$32.50



Parker Flex-Tip™ ET Tube, Preformed Nasal, Uncuffed

B091180	Size 3.0mm	5/box	\$32.50
B091181	Size 3.5mm	5/box	\$32.50
B091182	Size 4.0mm	5/box	\$32.50
B091183	Size 4.5mm	5/box	\$32.50
B091184	Size 5.0mm	5/box	\$32.50
B091185	Size 5.5mm	5/box	\$32.50
B091186	Size 6.0mm	5/box	\$32.50
B091187	Size 6.5mm	5/box	\$32.50
B091188	Size 7.0mm	5/box	\$32.50



Parker Flex-Tip™ ET Tube, Preformed Oral, Cuffed

B090880	Size 4.0mm	10/box	\$55.00
B090881	Size 4.5mm	10/box	\$55.00
B090882	Size 5.0mm	10/box	\$55.00
B090883	Size 5.5mm	10/box	\$55.00
B090884	Size 6.0mm	10/box	\$55.00
B090885	Size 6.5mm	10/box	\$55.00
B090886	Size 7.0mm	10/box	\$55.00
B090887	Size 7.5mm	10/box	\$55.00
B090888	Size 8.0mm	10/box	\$55.00
B090889	Size 8.5mm	10/box	\$55.00
B090890	Size 9.0mm	10/box	\$55.00

Parker Flex-Tip™ ET Tube, Preformed Oral, Uncuffed

B091080	Size 3.0mm	10/box	\$55.00
B091081	Size 3.5mm	10/box	\$55.00
B091082	Size 4.0mm	10/box	\$55.00
B091083	Size 4.5mm	10/box	\$55.00
B091084	Size 5.0mm	10/box	\$55.00
B091085	Size 5.5mm	10/box	\$55.00
B091086	Size 6.0mm	10/box	\$55.00



BiteMe™ Bite Block

BiteMe is an air-filled, bite block specifically designed to protect patient's teeth and airway devices during general anesthesia.

- Soft FDA approved food grade plastic
- Tapered distal end to allow easy placement between the teeth
- Concave side to allow close conformity when taped against airway
- Air-filled cavity creates compliant resistance to teeth clenching on waking up
- Depth markers to allow accurate positioning
- Distal end is blunt to decrease risk of trauma to delicate oral tissues
- Smooth finish makes it easy to insert and remove
- Single use and latex free
- Highly visible in the mouth
- Individually wrapped



Call for free samples!

B120029	BiteMe Bite Block Airway Protection	\$180	100/box
---------	-------------------------------------	-------	---------

Order Online: www.BellMedical.com customerservice@BellMedical.com

SPECIALTY ENDOTRACHEAL TUBES

Endotracheal Tube, Preformed Oral RAE Cuffed, Murphy Eye



B092320	Size 3.5mm	10/box	\$44.00
B092321	Size 4.0mm	10/box	\$44.00
B092322	Size 4.5mm	10/box	\$44.00
B092323	Size 5.0mm	10/box	\$44.00
B092324	Size 5.5mm	10/box	\$44.00
B092325	Size 6.0mm	10/box	\$44.00
B092326	Size 6.5mm	10/box	\$44.00
B092327	Size 7.0mm	10/box	\$44.00
B092328	Size 7.5mm	10/box	\$44.00
B092329	Size 8.0mm	10/box	\$44.00

Endotracheal Tube, Preformed Oral RAE Uncuffed, Murphy Eye



B092330	Size 3.0mm	10/box	\$41.75
B092331	Size 3.5mm	10/box	\$41.75
B092332	Size 4.0mm	10/box	\$41.75
B092333	Size 4.5mm	10/box	\$41.75
B092334	Size 5.0mm	10/box	\$41.75
B092335	Size 5.5mm	10/box	\$41.75
B092336	Size 6.0mm	10/box	\$41.75

Endotracheal Tube, Preformed Nasal RAE Cuffed, Murphy Eye



B092340	Size 3.5mm	10/box	\$44.00
B092341	Size 4.0mm	10/box	\$44.00
B092342	Size 4.5mm	10/box	\$44.00
B092343	Size 5.0mm	10/box	\$44.00
B092344	Size 5.5mm	10/box	\$44.00
B092345	Size 6.0mm	10/box	\$44.00
B092346	Size 6.5mm	10/box	\$44.00
B092347	Size 7.0mm	10/box	\$44.00

Endotracheal Tube, Preformed Nasal RAE Uncuffed, Murphy Eye



B092350	Size 3.0mm	10/box	\$41.75
B092351	Size 3.5mm	10/box	\$41.75
B092352	Size 4.0mm	10/box	\$41.75
B092353	Size 4.5mm	10/box	\$41.75
B092354	Size 5.0mm	10/box	\$41.75
B092355	Size 5.5mm	10/box	\$41.75
B092356	Size 6.0mm	10/box	\$41.75

EYE PROTECTION

EyePro Eyelid Occlusion Dressing - a clean and safe alternative to tape!

EyePro is a sterile dressing specifically designed to maintain eyelid closure during general anaesthesia while maintaining a clear view of the eyes. EyePro uses a “dual zone” adhesive system that maintains eye closure but allows safe and easy removal with minimal eyelid and eyelash trauma.

Call for free samples!

EyePro benefits:

- Packaged Sterile, two per package
- Dual zone adhesive with less adhesive on window protects eyes and eye lashes when applied/removed.
- Reduces skin tears, skin irritation and redness compared to tape.
- Dual non-adhesive tabs allow for easy application and removal, even with gloves



B100780 EyePro Eye Protection, 100 Each (50 Pair)/Box \$58.00

NoPress Eye Shield - use with EyePro!

The NoPress is a foam and rigid shield to protect patients' eyes from external pressure. The one-piece shield helps to distribute the pressure evenly around the bony area of the face.

Benefits include:

- Low profile to limit snags on drapes or cords
- Transparent shield allows patients eyes to be visible at all times
- Medical grade adhesive keeps mask in place and prevents allergic reactions

NoPress is safer for the patient and easy for the clinician to use. EyePro may be used in conjunction with NoPress eye shield providing total eye safety and control.

Call for free samples!

B100781 NoPress Eye Pressure Shield, 20/Box \$126.00



Saving Eyes Breakaway Face Protection Shield - use with EyePro!

- Medical-grade transparent plastic makes it easy to monitor patients during procedures
- Breakaway feature allows for rapid removal without disconnecting the breathing circuit
- T opening for use with ETT or LMAs
- Easy to apply with the included strap or a common mask harness
- Intended for adult patients in the supine position
- ANSI Z87 certified for impact protection

B100795 Saving Eyes Face Shield, 10/Box \$310.00



Order Online: www.BellMedical.com customerservice@BellMedical.com

IV INFUSION

TIVA, Total Intravenous Anesthesia

Ready Set Go! All-In-One TIVA Sets



Specifications: Universal spike, Back Check Valve, 2 Needleless Injection Ports, Pinch and Roller Clamps, Two Slide Clamps, Spin Connector:

- Primary Line length: 112" 18.0mL priming volume
- Green Microbore Line 72" .85mL priming volume
- Clear Minibore Line 72" 2.0mL priming volume

B300010	20 Drop Gravity TIVA Set (\$9.50 ea)	\$285	30/box
B300010C	20 Drop Gravity TIVA Set (\$8.10 ea) (4 boxes)	\$972	120/carton
B300015	60 Drop Gravity TIVA Set (\$9.50 ea)	\$285	30/box
B300015C	60 Drop Gravity TIVA Set (\$8.10 ea) (4 boxes)	\$972	120/carton

New TIVA Sets Coming in 2026

Designed to meet the highest standards as outlined by the SIVA, Euro SIVA and AAGBI guidelines.

- Leakage Prevention with fewer connections
- Anti-Siphon and Anti-Reflux Valves prevent Free Flow and Backflow ensuring control
- High Flow Rates with Wide Bore IV Gravity lines
- Minimal Dead Space
- Kink Resistance microbore tubing prevents occlusion
- Tangle-Free Design
- Cost Savings from reduced drug waste via microbore tubing
- Wide Range of Options, single, double, triple, quadrupole and quintuple infusion lines, in various lengths (2.0m, 2.2m, 2.5m, 3.0m, and 6.0m).
- Material Safety with DEHP Free PVC

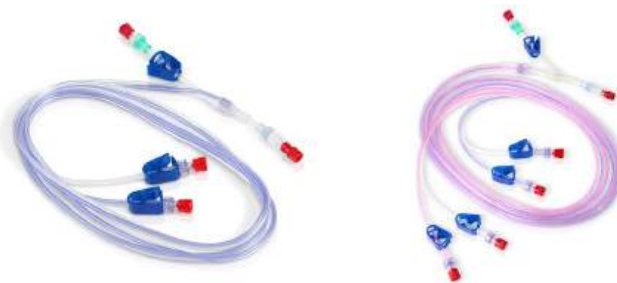

Call for options and pricing.

INFUSION AND IV

SmartStack IV Poles



Our specially designed pole base is 100% cast aluminum, providing extra stand support and durability. Its unique design will stack neatly with other bases of its kind, allowing for extra storage space, a more organized facility and easy transportation of multiple stands all at once.

- Unique stacking design with taller outer tube
- Large, smooth rolling casters with 2 wheel locks
- Includes 4 fixed Ram-horn hooks
- Easy, one-handed height adjustment
- Collapsed height of 65"; Extended height of 88"
- 48 month warranty



B130101	Each	\$641.50
B130101B	w/Basket	\$796.00
B130120	Basket only	\$154.00

PowerMATE®

The PowerMATE® is the only IV pole mountable power tap UL approved for use in patient care areas.

- Hospital Grade
- Cord management
- Safe and convenient access to additional outlets
- Increased equipment mobility with 15 foot power cord
- 1-Year Warranty

B040399, 20 amp	\$298.00
B040398, 15 amp	\$250.00



Pressure Infusion Bags, Disposable

The Unifusors are 100% tested for leakage during the manufacturing process. Designed for rapid IV infusion, invasive pressure monitoring and auto-transfusion procedures

- Includes IV pole loop
- Fluid bag hood
- Reinforced translucent sleeve
- Aneroid pressure gauge and stopcock release valve

B130803, 500cc	\$681.00	24/case
B130804, 1000cc	\$657.00	24/case
B130805, 3000cc	\$452.00	10/case



INTUBATION TOOLS

Eschmann Stylet (Bougie) - Disposable

The disposable endotracheal tube introducers and guides are individually packaged.

15 French for 6-11mm tubes, Angled Tip, Orange
(Clean and ready for patient use)

B091911 10/box \$72.00

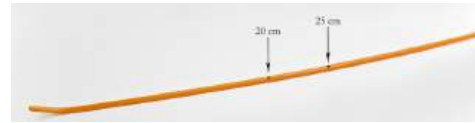

15 French for 6-11mm tubes, Angled Tip, Blue, Sterile

B190525 10/box \$122.00

B190524 Bougie-To-Go 10/box \$122.00



**New package option:
"Bougie-To-Go"**



10 French Pediatric, Angled Tip, Blue, Sterile

B190520 10/box \$115.00



Rigid Stylet - Reusable

For 6.0mm tubes and larger, each

B091996 Blue Handle \$24.50

B091902 Orange Handle \$52.00



Rigid Stylet - Disposable, 10/box

B190560 J-Wand with O2 Port, Sterile \$150.00

B190561 J-Wand with O2 Port, Non-Sterile \$150.00

B190562 Rtech, Non-Sterile \$78.50

B190563 Rtech, Sterile \$88.50



Eschmann Stylet (Bougie) with Oxygen Port - Disposable

The disposable endotracheal tube introducer and guides are sterile and individually packaged.

- Removable hose barb & 15mm Male fitting
- Coudé Tip with two eyes
- Length 70cm
- Marked to help determine depth

15 French for 6-11mm tubes, Angled Tip, 15mm Hose Barb

B190527

\$140.00/10



- Removable 15mm O2 Connector/Luer Lock
- Coudé Tip with two eyes
- Length 65cm
- Marked to help determine depth

15 French for 6-11mm tubes, Angled Tip, O2 Connector

B190540

\$138.00/5



- Removable 15mm O2 Connector/Luer Lock
- Coudé Tip with three eyes
- Length 65cm
- Marked to help determine depth

8 French, 40cm for ET tubes ≥ 3.5 , Angled Tip, O2 Connector

B190547 \$192.00/5

11 French, 65cm for ET tubes ≥ 5.0 , Angled Tip, O2 Connector

B190548 \$192.00/5

15 French, 65cm for ET tubes ≥ 6.0 , Angled Tip, O2 Connector

B190549 \$192.00/5



Trach Tube X-Changer, Disposable

- Soft, atraumatic, tip with oxygen port
- Depth markings

B200134 11Fr, 80cm fits ≥ 4.0 mm ID \$207/5

B200135 14Fr, 80cm fits ≥ 5.0 mm ID \$207/5

B200137 19Fr, 80cm fits ≥ 7.0 mm ID \$207/5



VIDEO AIRWAY MANAGEMENT SYSTEM

Insighters Video Intubation Solution for Total Airway Management



Insight Airway Management System Highlights:

- Video Laryngoscope with HD 3.5" color display portable; Macintosh 3 and 4 standard curve disposable blades, Macintosh 1,2,3,4 strong curved disposable blades
- Six Flexible Endoscopes sizes 2.2, 2.4, 3.6 and 3.5, 4.5, 5.2, and 5.8 with channels
- Rigid Endoscope 3.8mm OD
- iWorkstation, 13" HD color display with cabled and wireless capability
- Wireless connectivity to all airway devices

New from Insight: i-Core and i-Core Airways

- 2.2mm Flexible Endoscope compatible with 3.5" HD color display, wireless module or wired communication to iWorkstation allowing continuous monitoring of airway.
- Airways available; DLT, ET, Endo Blocker, LMA, Closed Suction Catheter.

VIDEO AIRWAY MANAGEMENT SYSTEM

Insighters Video Laryngoscope for Infant to Adult

Insighters video display fits Flexible Endoscopes, Rigid Scope and Video Laryngoscope providing a cost effective ONE SYSTEM solution.

iS-3 and iS-6 Display Features:

- High Definition, 1M Pixels, 3.5" Display
- 270° Rotation and Tilt
- Infant to Adult
- 3 Plus Hour Rechargeable Battery
- Removable Display for easy gas sterilization
- Wifi to iWorkstation
- Photo, Video with Sound Recording. 16GB, 70 hours of video or 80,000 photos
- Anti Fog Technology

iS-6 Additional Features:

- Infant Blade Tip
- 1M Pixel Camera



Optional Rigid Stylets

See Clearly, Do Easily.

Call for Free Evaluation!

B091990	iS-3 Video Laryngoscope, display, handle, recharger, case	\$2,995
B091991	iS-3 Infant SuperSmall (SS) Disposable Blade, 10/box	\$180
B091992	iS-3 Pediatric Small (S) Disposable Blade, 10/box	\$180
B091993	iS-3 Adult Medium (M) Disposable Blade, 10/box	\$180
B091994	iS-3 Adult Large (L) Disposable Blade, 10/box	\$180
B091953	iS-3 Adult Mac 3 Disposable Blade, 10/box	\$180
B091954	iS-3 Adult Mac 4 Disposable Blade, 10/box	\$180
B092990	iS-6 Video Laryngoscope, display, handle, recharger, case	\$3,335
B092991	iS-6 Infant SuperSmall (SS) Disposable Blade, 10/box	\$180
B092992	iS-6 Pediatric Small (S) Disposable Blade, 10/box	\$180
B092993	iS-6 Adult Medium (M) Disposable Blade, 10/box	\$180
B092994	iS-6 Adult Large (L) Disposable Blade, 10/box	\$180
Options:		
B091902	Rigid Intubation Stylet, Reusable, Orange Handle, Each	\$52.00
B091996	Rigid Intubation Stylet, Reusable, Blue Handle, Each	\$24.50

VIDEO AIRWAY MANAGEMENT SYSTEM

Insighters i-Core Video System and i-Core Airways



iCore Reusable Flexible Scope

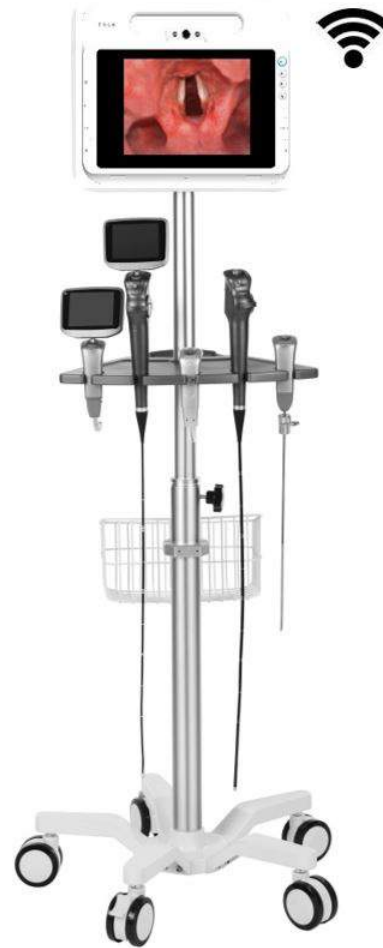

i-Core is Insighters 2.2mm reusable flexible scope that provides an “airway view” from the distal tip of any airway including the Insighters disposable i-Core airways.

Insighters i-Core Airway Management System Highlights:

- 2.2mm Flexible Endoscope compatible with 3.5” HD color display or wireless video to iWorkstation allowing continuous monitoring of airways such as LMA, ET or DLT.

New i-Core Insighters FDA approved disposable products:

- i-Core LMA sizes 3,4,5
- i-Core ET tube adapter
- i-Core Closed Suction Catheter, 72 hour and 24 hour, Adult and Pediatric versions
- i-DLT* Double Lumen, i-ET* tracheal tube, i-Block* Endobrochial blocker, *pending FDA

B091999 iCore, Insight 2.2mm Flexible Scope, non-articulating	\$3,000	each
B092900 Insight iWorkstation with 13” HD wireless display	\$4,600	each
B091970 Roll Stand and Scope Holder for 4 Insight devices	\$ 865	each

VIDEO AIRWAY MANAGEMENT SYSTEM

Insighters i-Core Consumables with dedicated i-Core Channels

Endotracheal Tubes*, Cuffed, \$45.00 10/box

B093160	6.0mm
B093165	6.5mm
B093170	7.0mm
B093175	7.5mm
B093180	8.0mm
B093185	8.5mm

Endotracheal Tubes*, Cuffed, Wire Reinforced, \$180.00 10/box

B093260	6.0mm
B093265	6.5mm
B093270	7.0mm
B093275	7.5mm
B093280	8.0mm
B093285	8.5mm

Endotracheal Tubes*, Cuffed, Suction, \$85.00 10/box

B093360	6.0mm
B093365	6.5mm
B093370	7.0mm
B093375	7.5mm
B093380	8.0mm
B093385	8.5mm

Endotracheal Tubes*, Cuffed, Suction, Wire Reinforced, \$220.00 10/box

B093460	6.0mm
B093465	6.5mm
B093470	7.0mm
B093475	7.5mm
B093480	8.0mm
B093485	8.5mm

Endobronchial Blocker*, \$89.00 each

B090305	5Fr
B090307	7Fr
B090309	9Fr

Subglottic Airway Gastric Suction, Intubating Airway, \$180.00 10/box

B121303	Size 3
B121304	Size 4
B121305	Size 5

Double Lumen Tube*, Left, \$73.00 each

B090061	28Fr
B090062	32Fr
B090063	35Fr
B090064	37Fr
B090065	39Fr
B090066	41Fr

Double Lumen Tube*, Right, \$97.00 each

B090071	28Fr
B090072	32Fr
B090073	35Fr
B090074	37Fr
B090075	39Fr
B090076	41Fr

Closed Suction Catheter, 72 Hours, \$95.00 10/box

B091421	6Fr
B091422	8Fr
B091423	10Fr
B091424	12Fr
B091425	14Fr
B091426	16Fr

Closed Suction Catheter, 24 Hours, \$89.00 10/box

B091431	6Fr
B091432	8Fr
B091433	10Fr
B091434	12Fr
B091435	14Fr
B091436	16Fr

Closed Suction Catheter, Pediatric, \$95.00 10/box

B091416	6Fr
B091418	8Fr

Endotracheal Tube Airway Adaptor B010999 \$50.00 20/box

* FDA approval in early 2023

VIDEO AIRWAY MANAGEMENT SYSTEM

Insighters Video Rigid "Lighted" Stylet Malleable Intubation Solution



Rigid video intubation scope with oxygen insufflation capability.

Integrated Insight video display is multi-functional fitting Rigid Scope, Flexible Endoscope and Video Laryngoscope providing a convenient & cost effective ONE SYSTEM solution.

Preload your endotracheal tube along rigid yet malleable scope locking it in place with pressure ring. View vocal cords and slide ET tube into trachea.

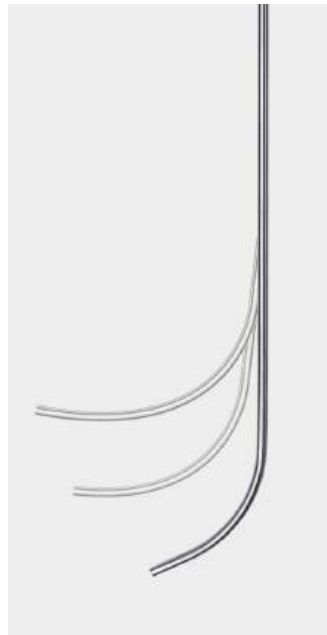

**The Future
is
Bright
with
Insighters!**

B091998 Rigid Laryngoscope, display, recharger, case \$5,335

B091998H Rigid Laryngoscope handle only, without display \$3,270

VIDEO AIRWAY MANAGEMENT SYSTEM

Insighters Flexible Video Endoscope Solutions for Airway Management

Reusable endoscopes with digital camera are available in multiple diameters from infant to adult with and without working channels to meet your flexible scope needs.



Ultralight Articulating Flexible Endoscopes without Display

B091999LSH	5.8mm scope with 3.0mm channel	\$9,790
B091999SH	5.2mm scope with 2.6mm channel	\$9,790
B091999ISH	4.5mm scope with 2.0mm channel	\$9,790
B092035C	3.5mm scope with 1.2mm channel	\$9,790
B091999IH	2.4mm scope	\$9,190
B091999	iCore, 2.2mm Flexible Scope, non-articulating	\$3,000
B091990D	Insighters Universal 3.5" Color Display only	\$2,065

Disposable Flexible Endoscopes without Display



New in 2026!

Call for options and pricing.

LARYNGOSCOPES: DISPOSABLE COMBO

Disposable Laryngoscope Blade & Handle Combination Package

Conventional Blades and Handles with "LED" Technology:

- Ready to use combo package
- Easy operation and light verification testing without opening package
- Superior light from high powered LED at end of blade
- Single patient use, individually packaged clean, non-sterile
- Available in all sizes of Miller and MacIntosh blades.
- Minimizes risk of cross contamination
- Blades made of surgical steel with polymer handles

Best Value!



Macintosh and Miller Metal Blade with Plastic Handle \$89.50 (10/box)

B154201P	MAC 1 Conventional LED Laryngoscope Blade, Small Handle
B154202	MAC 2 Conventional LED Laryngoscope Blade, Medium Handle
B154202P	MAC 2 Conventional LED Laryngoscope Blade, Small Handle
B154203	MAC 3 Conventional LED Laryngoscope Blade, Medium Handle
B1542035	MAC 3.5 Conventional LED Laryngoscope Blade, Medium Handle
B154203P	MAC 3 Conventional LED Laryngoscope Blade, Small Handle
B154204	MAC 4 Conventional LED Laryngoscope Blade, Medium Handle
B154204P	MAC 4 Conventional LED Laryngoscope Blade, Small Handle
B154260	MILLER 0 Conventional LED Laryngoscope Blade, Medium Handle
B154260P	MILLER 0 Conventional LED Laryngoscope Blade, Small Handle
B154261P	MILLER 1 Conventional LED Laryngoscope Blade, Small Handle
B154262	MILLER 2 Conventional LED Laryngoscope Blade, Medium Handle
B154262P	MILLER 2 Conventional LED Laryngoscope Blade, Small Handle
B154263	MILLER 3 Conventional LED Laryngoscope Blade, Medium Handle
B154264	MILLER 4 Conventional LED Laryngoscope Blade, Medium Handle
B154269P	MILLER 00 Conventional LED Laryngoscope Blade, Small Handle

LARYNGOSCOPES: DISPOSABLE COMBO

Disposable Laryngoscope Blade & Handle Combination Package

Single patient use conventional LED laryngoscope blades and handles in a single ready to use package. Light weight anodized aluminum handles with pre-installed batteries. Special packaging allows easy battery and light verification before opening package.



LARYNGOSCOPES : DISPOSABLE

Macintosh Laryngoscope Blades with Aluminum Handles

Single patient use, individually packaged clean, non-sterile.

B154110	Macintosh 0 Small	\$113.00	10/bx
B154111	Macintosh 1 Small	\$113.00	10/bx
B154112	Macintosh 2 Medium	\$113.00	10/bx
B154112S	Macintosh 2 Stubby	\$113.00	10/bx
B154113	Macintosh 3 Medium	\$113.00	10/bx
B154113S	Macintosh 3 Stubby	\$113.00	10/bx
B154113S	Macintosh 3.5Medium	\$113.00	10/bx
B154114	Macintosh 4 Medium	\$113.00	10/bx
B154114S	Macintosh 4 Stubby	\$113.00	10/bx

Call for Contract Pricing!



Miller Laryngoscope Blades with Aluminum Handles

Single patient use, individually packaged, clean, non-sterile.

B154129	Miller 00	Small	\$113.00	10/bx
B154120	Miller 0	Small	\$113.00	10/bx
B154121	Miller 1	Small	\$113.00	10/bx
B154122	Miller 2	Medium	\$113.00	10/bx
B154122S	Miller 2	Stubby	\$113.00	10/bx
B154123	Miller 3	Medium	\$113.00	10/bx
B154123S	Miller 3	Stubby	\$113.00	10/bx
B154124	Miller 4	Medium	\$113.00	10/bx
B154124S	Miller 4	Stubby	\$113.00	10/bx

LARYNGOSCOPES: DISPOSABLE FIBER OPTIC

Fiber Optic Green System Disposable Laryngoscope Blades and Handles

Single patient use Green System laryngoscope blades are coupled with our high output ultra-bright LED handles to provide superior brightness to meet the most demanding intubation situations.

Macintosh Fiber Optic Laryngoscope Blades

Single patient use, individually packaged clean, non-sterile.

B154010	Macintosh 0	\$104.00	20/bx
B154011	Macintosh 1	\$104.00	20/bx
B154012	Macintosh 2	\$104.00	20/bx
B154013	Macintosh 3	\$104.00	20/bx
B154014	Macintosh 4	\$104.00	20/bx



Miller Fiber Optic Laryngoscope Blades

Single patient use, individually packaged clean, non-sterile.

B154029	Miller 00	\$104.00	20/bx
B154020	Miller 0	\$104.00	20/bx
B154021	Miller 1	\$104.00	20/bx
B154022	Miller 2	\$104.00	20/bx
B154023	Miller 3	\$104.00	20/bx
B154024	Miller 4	\$104.00	20/bx



Green System Laryngoscope Handles, LED Lamps and Batteries

Aluminum with ultra-bright LED technology. Single patient use, individually packaged clean, non-sterile.

Fiber Optic Laryngoscope Handles will fit any Fiber Optic Blade, see pages 43-49.

B154000	Medium Handle	\$80.00	10/bx
B154001	Penlight Handle	\$80.00	10/bx
B154002	Stubby Handle	\$80.00	10/bx



LARYNGOSCOPES: DISPOSABLE FIBER OPTIC

LARYNGOSCOPES : DISPOSABLE

Flexicare BriteBlade Pro Disposable Laryngoscope Blades

BriteBlade Pro is a metal disposable fibre optic blade designed for single patient use which eliminates risk of cross contamination from both blade and handle. It has a unique hinge design that prevents the folded blade from touching the handle.



**Sterile
Packaged**

Macintosh Disposable Laryngoscope Blades

\$80.30 10/package

B151821	Mac 1	B151826	Mac 3.5
B151822	Mac 2	B151827	Mac Strong Curve
B151823	Mac 3	B151824	Mac 4

Miller Disposable Laryngoscope Blades

\$80.30 10/package

B151839	Miller 00	B151832	Miller 2
B151830	Miller 0	B151833	Miller 3
B151831	Miller 1	B151834	Miller 4

Phillips Disposable Laryngoscope Blades

\$80.30 10/package

B151852	Philips 2
---------	-----------



Mini Handle

Laryngoscope BritePro Solo Handles

\$305.00 20/package

B151900	Complete Disposable Handle only, Medium/Standard
B151901	Complete Disposable Handle only, Mini

Laryngoscope Blade with BritePro Solo Handle

Complete laryngoscope solution that combines disposable LED handle and fiber optic blade in a single, sterile pack. BritePro Solo is always ready for use when you are.

- No Risk of cross contamination

\$202.00 10/box

B151921	Handle and Mac 1	B151939	Handle and Miller 00
B151922	Handle and Mac 2	B151930	Handle and Miller 0
B151923	Handle and Mac 3	B151931	Handle and Miller 1
B151924	Handle and Mac 4	B151932	Handle and Miller 2
		B151933	Handle and Miller 3
		B151934	Handle and Miller 4

LARYNGOSCOPES: HEINE FIBER OPTIC

Reusable Laryngoscope Blades

B157310	Macintosh 0	\$303.70	each
B157311	Macintosh 1	\$303.70	each
B157312	Macintosh 2	\$303.70	each
B157313	Macintosh 3	\$303.70	each
B157314	Macintosh 4	\$303.70	each
B157315	Macintosh 5	\$332.00	each
B157330	Pediatric Size 0	\$303.70	each
B157331	Pediatric Size 1	\$303.70	each
B157329	Miller 00	\$303.70	each
B157320	Miller 0	\$303.70	each
B157321	Miller 1	\$303.70	each
B157322	Miller 2	\$303.70	each
B157323	Miller 3	\$303.70	each
B157324	Miller 4	\$332.00	each
B157337	Wisconsin 1	\$332.00	each
B157338	Wisconsin 2	\$332.00	each
B157339	Wisconsin 3	\$332.00	each



Ten year warranty!



Disposable Plastic, MRI Compatible Laryngoscope Blades, \$195 25/box

B155211	Disposable XP Macintosh 1
B155212	Disposable XP Macintosh 2
B155213	Disposable XP Macintosh 3
B155214	Disposable XP Macintosh 4
B155221	Disposable XP Miller 0
B155222	Disposable XP Miller 1
B155223	Disposable XP Miller 2
B155224	Disposable XP Miller 3
B155225	Disposable XP Miller 4



Reusable Laryngoscope Handles \$363 each

Approved for hand wipe disinfection!

B157300	EasyClean LED Laryngoscope Handle
B157301	EasyClean LED Slim Laryngoscope Handle
B157302	EasyClean LED Stubby Laryngoscope Handle



LARYNGOSCOPES: HEINE VIDEO LARYNGOSCOPE

visionPRO Video Laryngoscope



“We tried it and the optics are great!” Anesthesiologist, Washington University, Barnes Hospital, St. Louis, MO.

Nothing is more important than a great view of the glottis. The new HEINE visionPRO video laryngoscope provides a bright, high-definition, realistic color representation of the vocal cords.

- Outstanding image quality using LED HQ light source and bright 3.2” adjustable display
- Durable product design using anodized aluminum display and stainless-steel handle
- Ecological & economical using rechargeable lithium battery and upcycled blade material
- Realistic color representation due to smart image processing and Heine LED HQ

B093100	Heine visionPRO video laryngoscope and recharger base	\$3,850*	Each
B093112	MacIntosh 2 disposable blade sheath	\$180	10/box
B093152	MacIntosh 2 disposable blade sheath	\$810	50/box
B093113	MacIntosh 3 disposable blade sheath	\$180	10/box
B093153	MacIntosh 3 disposable blade sheath	\$810	50/box
B093114	MacIntosh 4 disposable blade sheath	\$180	10/box
B093154	MacIntosh 4 disposable blade sheath	\$810	50/box

***Ask about our McGrath price matching program and contact us for a free trial.**

LARYNGOSCOPES: REUSABLE FIBER OPTIC

Integrated Fiber Optic GreenSpec German Profile Laryngoscope Blades

Built with an integral, extra large fiber optic bundle providing cool, white light. Integral fiber optic design enables superior cleaning by elimination of cracks and crevices.

Macintosh, Fiber Optic

B152200	0 Neonate	\$58.00
B152201	1 Infant	\$58.00
B152202	2 Child	\$58.00
B152203	3 Medium Adult	\$58.00
B1522035	3 ½ Medium Adult	\$58.00
B152204	4 Large Adult	\$58.00



Miller, Fiber Optic

B153309	00 Premature	\$58.00
B153300	0 Newborn	\$58.00
B153301	1 Infant	\$58.00
B153302	2 Child	\$58.00
B153303	3 Medium Adult	\$58.00
B153304	4 Large Adult	\$58.00



Bell Medical Guarantee!
Minimum 3% savings compared to any competitors catalog pricing.

Reusable Laryngoscope Handles for Fiber Optic Blades

Fiber Optic Laryngoscope Handles will fit any Greenline Fiber Optic Blade

All with LED Light



B157100	Bell Medical, Medium/Standard C Batteries	\$96.00
B157102	Bell Medical, Compact/Slim AA Batteries	\$96.00
B157101	Bell Medical, Light/Stubby AA Batteries	\$96.00

Also see Heine EasyClean page 44

LARYNGOSCOPES: REUSABLE MRI COMPATIBLE



LARYNGOSCOPES: REUSABLE MRI

MRI Fiberoptic Macintosh Laryngoscope Blades

(American design has flattened curve and longer light to tip distance)

B152500	MRI Compatible Laryngoscope Blade, American Macintosh 0	\$180.00
B152501	MRI Compatible Laryngoscope Blade, American Macintosh 1	\$180.00
B152502	MRI Compatible Laryngoscope Blade, American Macintosh 2	\$180.00
B152503	MRI Compatible Laryngoscope Blade, American Macintosh 3	\$180.00
B152505	MRI Compatible Laryngoscope Blade, American Macintosh 3½	\$180.00
B152504	MRI Compatible Laryngoscope Blade, American Macintosh 4	\$180.00



American Macintosh



English Macintosh

MRI Fiberoptic English Macintosh Laryngoscope Blades

(English design has full curve and shorter light to tip distance)

B152510	MRI Compatible Laryngoscope Blade, English Macintosh 1	\$180.00
B152511	MRI Compatible Laryngoscope Blade, English Macintosh 2	\$180.00
B152512	MRI Compatible Laryngoscope Blade, English Macintosh 3	\$180.00
B152513	MRI Compatible Laryngoscope Blade, English Macintosh 4	\$180.00

MRI Fiberoptic Miller Laryngoscope Blades

B152520	MRI Compatible Laryngoscope Blade, Miller 0	\$180.00
B152521	MRI Compatible Laryngoscope Blade, Miller 1	\$180.00
B152522	MRI Compatible Laryngoscope Blade, Miller 2	\$180.00
B152523	MRI Compatible Laryngoscope Blade, Miller 3	\$180.00
B152524	MRI Compatible Laryngoscope Blade, Miller 4	\$180.00

MRI Fiberoptic Wisconsin Laryngoscope Blades

B152532	MRI Compatible Laryngoscope Blade, Wisconsin 2	\$180.00
B152533	MRI Compatible Laryngoscope Blade, Wisconsin 3	\$180.00
B152534	MRI Compatible Laryngoscope Blade, Wisconsin 4	\$180.00

MRI Fiberoptic Handle (Requires MRI "C" Battery (not included))

B152550	MRI Compatible Laryngoscope Handle, Medium	\$495.00
B152551	MRI Compatible Laryngoscope Handle, Short	\$495.00

MRI Battery

B152595 MRI "C" Compatible
Lithium Battery for B152550 Handle,
2/pack \$464.00



MRI Halogen Bulb

B152599 MRI Compatible Light Bulb
for B152550 Handle, 5/pack \$130.00

LARYNGOSCOPES: DISPOSABLE MRI COMPATIBLE

Heine Disposable Plastic, MRI Compatible Laryngoscope Blades, \$153 25/box

- B155211 Disposable XP Macintosh 1
- B155212 Disposable XP Macintosh
- B155213 Disposable XP Macintosh
- B155214 Disposable XP Macintosh

- B155221 Disposable XP Miller 0
- B155222 Disposable XP Miller 1
- B155223 Disposable XP Miller 2
- B155224 Disposable XP Miller 3
- B155225 Disposable XP Miller 4



Disposable Plastic, MRI Compatible Laryngoscope Blades \$75 10/box

- B152141 Macintosh 1
- B152142 Macintosh 2
- B152143 Macintosh 3
- B152144 Macintosh 4

- B152159 Miller 00
- B152150 Miller 0
- B152151 Miller 1
- B152152 Miller 2
- B152153 Miller 3



Disposable, MRI Compatible Laryngoscope Handle \$245.50 10/box

- B152130 Adult/Medium, two MRI batteries with 10 handles

MRI Compatible Battery Pack \$55.00 each

- B152131 MRI conditional battery pack for use with B152130 handle



LARYNGOSCOPE SAFETY

DentaSafe, Intubation Dental Guard, reduces dental trauma and lawsuits



DentaSafe Advantages:

- Easy to apply and use
- Medical grade elastic cushion
- Hypoallergenic
- Latex free
- Made in USA

**Call 800-875-2355
for free samples!**

"Dental damage is the most common claim made against anesthesia making up 20-30% of claims."

DentaSafe helps prevent costly damage to the upper incisors, which are the most frequently affected teeth during intubation. Single use, disposable foam strip attaches to the flange of the laryngoscope blade and prevents direct contact between the metallic blade and the patient's upper teeth.

B157900 DentaSafe Laryngoscope Tooth Protection (25 pair) \$138.50 50/Box

i-view™ Video Laryngoscope, one size, single use

i-view is the new, single use, fully disposable video laryngoscope.

By incorporating a Macintosh blade, i-view can also be used for direct laryngoscopy. i-view is ready to use in seconds after removing from the packaging. Ergonomic design ensures i-view is easy and instinctive to use, and the integral LCD screen provides a view in a variety of light conditions.

Key advantages:

- Better view of the larynx
- Reduced head and neck manipulation
- Less force required
- Reduced attempts at laryngoscopy
- Higher success rate than direct laryngoscopy



B092800 i-view™ Video Laryngoscope \$248.00 2/Box

Bell Medical, Inc. 314-772-5600 800-875-BELL (2355)

LARYNGEAL MASK AIRWAYS

EndoMask Eclipse 100% Silicon Disposable Laryngeal Mask Airway

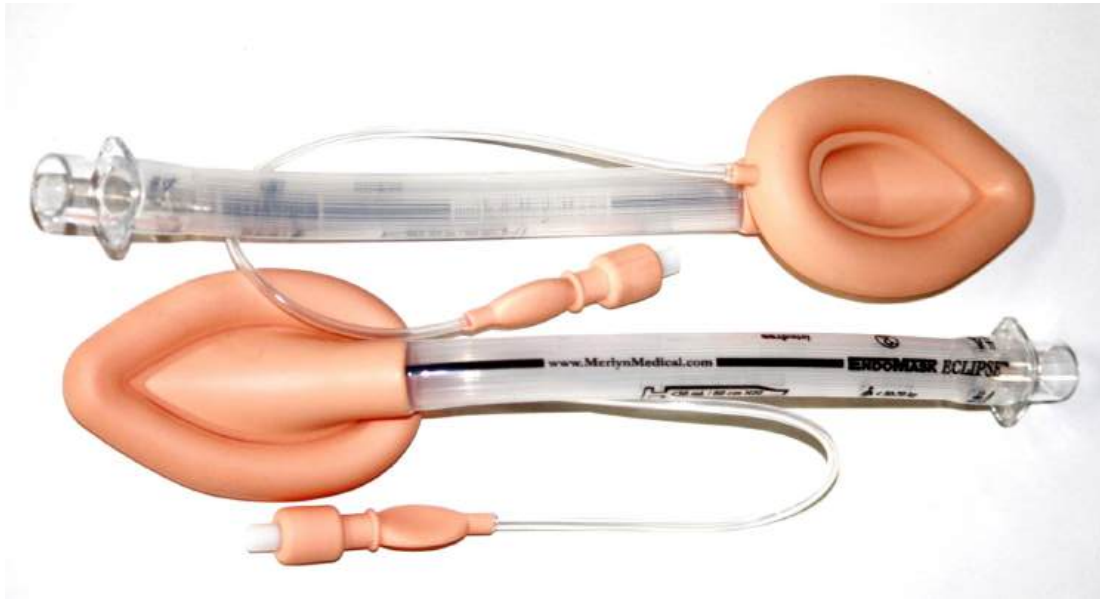

Eclipse Comfort Seal 100% Silicon LMA

- **Superior silicone cuffs** that conform to the natural contours of the hypopharynx for perfect fit, allowing rapid insertion, excellent seal, and single-hand ventilation. Cuffs are thick and durable with a smooth matte finish.
- **No epiglottic bars** (aperture bars), enable easy access for fiberscope and suction catheters.
- **The finest premium-grade silicone** is used in the manufacture of EndoMask® products. Our cuff assembly and tube body is smoother.
- **Manufacture** of EndoMask is under the strictest quality control and sterile conditions. Our plant operates under certification of ISO and is compliant with FDA and CE standards.
- **All EndoMask products utilize 100 percent latex free** manufacturing and packaging materials.

Silicone Laryngeal Mask Size 1	B121110	\$48.00/5
Silicone Laryngeal Mask Size 1.5	B121118	\$48.00/5
Silicone Laryngeal Mask Size 2	B121120	\$48.00/5
Silicone Laryngeal Mask Size 2.5	B121129	\$48.00/5
Silicone Laryngeal Mask Size 3	B121130	\$48.00/5
Silicone Laryngeal Mask Size 4	B121140	\$48.00/5
Silicone Laryngeal Maskk Size 5	B121150	\$48.00/5

Bell Medical Guarantee!
Minimum 3% savings compared to any competitors catalog pricing.

LARYNGEAL MASK AIRWAYS

i-gel Supraglottic Airway



i-gel is a unique, single use, supraglottic airway management device made from a medical grade thermoplastic elastomer. i-gel has been designed to create a non-inflatable, anatomical seal of the pharyngeal, laryngeal and perilaryngeal structures whilst avoiding compression trauma.

Benefits of the i-gel:

- Unique, soft, gel-like material allows ease of insertion and reduced trauma
- Gastric channel designed to improve and enhance patient safety
- Integral bite-block
- Stability with buccal cavity stabilizer virtually eliminates rotation
- Positive pressure ventilating capabilities
- Intubating Airway, Latex free and PVC free

B121001	i-gel Supraglottic Airway, Size 1	\$194.00	10/case
B121008	i-gel Supraglottic Airway, Size 1.5	\$194.00	10/case
B121002	i-gel Supraglottic Airway, Size 2	\$194.00	10/case
B121009	i-gel Supraglottic Airway, Size 2.5	\$194.00	10/case
B121003	i-gel Supraglottic Airway, Size 3	\$484.00	25/case
B121004	i-gel Supraglottic Airway, Size 4	\$484.00	25/case
B121005	i-gel Supraglottic Airway, Size 5	\$484.00	25/case
8703030	i-gel O2 Resus Pack, Size 3	\$221.00	6/case
8704030	i-gel O2 Resus Pack, Size 4	\$221.00	6/case
8705030	i-gel O2 Resus Pack, Size 5	\$221.00	6/case

i-gel® O2 Resus Pack, includes i-gel® O2 with colored hook ring, sachet of lubricant, airway support strap and a 12FG suction tube

LARYNGEAL MASK AIRWAYS STRAIGHT

Disposable Laryngeal Mask, 100% Silicone

- 100% Medical Grade Silicone Cuff
- Packaged Sterile; ready for use

100% Silicone Cuff & Tube \$110.00 per box of 10

B120110	Size 1.0	B120130	Size 3.0
B120115	Size 1.5	B120140	Size 4.0
B120120	Size 2.0	B120150	Size 5.0
B120125	Size 2.5	B120160	Size 6.0

100% Silicone Cuff & Tube, MRI Compatible \$125.00 per box of 10

B120210	Size 1.0	B120230	Size 3.0
B120215	Size 1.5	B120240	Size 4.0
B120220	Size 2.0	B120250	Size 5.0
B120225	Size 2.5	B120260	Size 6.0

100% Silicone Cuff & Tube, Reinforced \$250.00 per box of 10

B120310	Size 1.0	B120330	Size 3.0
B120315	Size 1.5	B120340	Size 4.0
B120320	Size 2.0	B120350	Size 5.0
B120325	Size 2.5	B120360	Size 6.0



Disposable Laryngeal Mask, Silicone Cuff with PVC Tube

- 100% Medical Grade Silicone Cuff with PVE tube
- Packaged Sterile; ready for use

Silicone Cuff with PVC Tube \$90.00 per box of 10

B120410	Size 1.0	B120430	Size 3.0
B120415	Size 1.5	B120440	Size 4.0
B120420	Size 2.0	B120450	Size 5.0
B120425	Size 2.5	B120460	Size 6.0

Silicone Cuff with PVC Tube, MRI Compatible \$115.00 per box of 10

B120510	Size 1.0	B120530	Size 3.0
B120515	Size 1.5	B120540	Size 4.0
B120520	Size 2.0	B120550	Size 5.0
B120525	Size 2.5	B120560	Size 6.0

Reusable Laryngeal Mask, 100% Silicone

- 100% Medical Grade Silicone Cuff and Tube with ABS/PC connector/valve
- All sizes available, neonate through large adult • Non-fenestrated for easier insertion of diagnostic tools

100% Silicone Cuff & Tube \$135.00 each

B120610	Size 1.0	B120630	Size 3.0
B120615	Size 1.5	B120640	Size 4.0
B120620	Size 2.0	B120650	Size 5.0
B120625	Size 2.5	B120660	Size 6.0

100% Silicone Wire Reinforced \$165.00 each

B120810	Size 1.0	B120830	Size 3.0
B120815	Size 1.5	B120840	Size 4.0
B120820	Size 2.0	B12085	Size 5.0
B120825	Size 2.5	N/A	Size 6.0

ANESTHESIA MACHINES

M

MINDRAY ANESTHESIA MACHINES

Mindray A Series Anesthesia System

The A4 Anesthesia System combines the familiarity of traditional bellows with digital technology to meet the needs of a wide range of patients in mid-acuity hospitals and ambulatory surgery centers. The intuitive user interface with touchscreen display facilitates changes in ventilation modes and settings. The A4 delivers advanced ventilation with an easy to use and cost effective anesthesia delivery system.



- 15" color touchscreen with digital flow meters and customizable settings
- 6+ modes of ventilation options
- Warmed breathing system virtually eliminates internal condensation
- Automatic compliance and fresh gas compensation maintain accurate tidal volumes.
- Economical single container absorber reduces compressible volume and accepts non-proprietary pre-packaged and loose fill absorbent
- Auxiliary O2 / Air flow meters deliver blended gas to reduce the risk of airway fire
- HL7 connectivity for AIMS and EMR integration
- Available with optional Mindray patient monitor

**Call 800-875-2355
for quotation!**

3 Year Warranty!



The 15" color touchscreen enables clinicians to easily view and select ventilation settings.



Heated absorber eliminates moisture issues plus CO2 absorber can be quickly changed during case and uses non-proprietary pre-pack absorbent.

PATIENT MONITORS

Mindray ePM Patient Monitors: Easy i-Phone Touch Display



Features

- 10", 12" and 15" multi-gesture, capacitive HD color touchscreen displays, easy user interface
- Waveform capability: ePM 10", 8 waveforms, ePM 12', 10 waveforms
- Integrated parameters: 3 & 5-lead ECG, Masimo SET® SpO2, NIBP, RESP, TEMP
- Optional Nellcor® OxiMax® SpO2 available
- Arrhythmia analysis with atrial fibrillation (Afib) detection standard
- Optional ST and QT/QTc monitoring
- Extensive data storage for trend data, alarms, events, and 48 hours of full disclosure
- Optional Sidestream or Microstream® CO2 module and Multi-gas module (ePM 12M only)
- Wireless monitoring to central station option
- Integrated HL7 and DIAP communication protocol for interface to EMR

Mindray ePM10 with 10" HD Color Display

B400410 3/5 lead ECG, Arrhythmia, Masimo SpO2, NIBP, temp, resp	\$5,000
B400419 3/5 lead ECG, Arrhythmia, Nellcor SpO2, NIBP, temp, resp	\$4,745

Mindray ePM12 with 12" HD Color Display

B400420 3/5 lead ECG, Arrhythmia, Masimo SpO2, NIBP, temp, resp	\$6,675
B400429 3/5 lead ECG, Arrhythmia, Nellcor SpO2, NIBP, temp, resp	\$6,420

Mindray ePM15 with 15" HD Color Display

B400420 3/5 lead ECG, Arrhythmia, Masimo SpO2, NIBP, temp, resp	\$9,365
B400429 3/5 lead ECG, Arrhythmia, Nellcor SpO2, NIBP, temp, resp	\$9,340

Optional CO2 Modules for ePM10/ePM12

B400401 Mindray Sidestream CO2 Module, Adult/Pediatric	\$2,775
B400402 Oridion Microstream CO2 Module, Adult/Pediatric	\$3,330
B400403 Multi-gas CO2 and Agent module (ePM 12M only)	\$6,715

Mindray Accutorr 3 Vital Signs Monitors

B400121 Nellcor SPO2, NIBP, SmarTemp and Pulse Rate	\$2,240
B400122 Masimo SPO2, NIBP, SmarTemp and Pulse Rate	\$2,340

Order Online: www.BellMedical.com customerservice@BellMedical.com

MINDRAY MONITOR ACCESSORIES



Lithium-Ion Battery, 11.1V for
B312050 Passport 8,12 and A-Series Machines **\$255.00 each**
B312051 ePM 10 and 12 Monitors **\$255.00 each**



Paper, Thermal Strip, 50mm width, 30m length
B312055 **\$73.35 12/box**

Mindray - ETCO2



Dryline Water Trap - Adult/Pediatric for Passport 8, 12
B203219B **\$231.00 10/box**



Dryline II Water Trap - Adult/Pediatric for ePM 10, 12
B203217 **\$231.00 10/box**



Gas Sampling Line, Adult/Pediatric, 10', Male x Male
B030901 **\$85.80 50/box**



Comfort Soft ETCO2 Sampling Line with O2 delivery,
 Adult/Pediatric, 10', Male Connector w/ Female adapter
B180030 **\$61.00 25/box**

Mindray - ECG Cables and Lead Wires



ECG Cable, 3/5 Lead
B312000 **\$105.00 each**



ECG Operating Room Cable,
 3/5 Lead, ESIS
B312001 **\$125.00 each**



ECG Lead Wires, 3 Lead, Snap, 24"
 ECG Lead Wires, 3 Lead, Snap, 36"

B312015 **\$95.00 set**
B312025 **\$105.00 set**



ECG Lead Wires, 3 Lead, Pinch/Clip, 24"
 ECG Lead Wires, 3 Lead, Pinch/Clip, 36"

B312014 **\$105.00 set**
B312024 **\$115.00 set**



ECG Lead Wires, 5 Lead, Snap, 24"
 ECG Lead Wires, 5 Lead, Snap, 36"

B312019 **\$135.00 set**
B312029 **\$145.00 set**



ECG Lead Wires, 5 Lead, Pinch/Clip, 24"
 ECG Lead Wires, 5 Lead, Pinch/Clip, 36"

B312018 **\$145.00 set**
B312028 **\$155.00 set**

Mindray - Nellcor SPO2



Nellcor Oximax SPO2
 Cable, 8 pin"
B203030 **\$150.00 each**



Nellcor SPO2 Finger
 Sensor, Adult
B203060 **\$150.00 each**

MINDRAY MONITOR ACCESSORIES

Mindray Reusable NIBP Cuffs

NIBP Hose with Connectors, Reuable
B203095 \$31.00 each



Blood Pressure Cuff with Slotted Male Connectors, Reuable

- B020310 Infant/Sm Child 10-19 cm \$24.00 each**
- B020311 Child/SM Adult 18-26 cm \$25.00 each**
- B020312 Adult 25-35 cm \$27.00 each**
- B020312L Adult Long 25-35 cm \$33.50 each**
- B020313 Large Adult 33-47 cm \$33.75 each**
- B020313L Large Adult Long 33-47 cm \$35.00 each**
- B020314 Thigh 46-66 cm \$45.00 each**



Blood Pressure Cuff with Slotted Male Connectors, Reuable, Latex Free

- B020315 Infant/Sm Child 10-19 cm \$24.00 each**
- B020316 Child/SM Adult 18-26 cm \$25.00 each**
- B020317 Adult 25-35 cm \$27.00 each**
- B020318 Large Adult 33-47 cm \$33.75 each**
- B020319 Thigh 46-66 cm \$45.00 each**



Mindray Monitor Mounting Options



Roll Stand with Quick Release Mount
 for ePM10 and ePM12
B203554 \$445.00



M Series Wall Mount with Quick
 Release for ePM10 and ePM12
B203550 \$480.00



VHM Series Wall Mount with
 Quick Release for ePM10
 and ePM12
B203531 \$1,205.00



Bedrail Clamp for ePM10 and
 ePM12
B203558 \$154.00

Mindray Temperature

Esophageal Stethoscope w/400 Series Temperature

- 9 French B190240 50/Box \$240.00**
- 12 French B190241 50/Box \$240.00**
- 18 French B190242 50/Box \$240.00**
- 24 French B190243 50/Box \$308.00**

Skin Temperature Sensor, 400
 Series
B190259 50/Box \$185.00

ANESTHESIA MACHINES

Preowned Anesthesia Machines

Bell Medical, Inc. offers preowned GE, Drager, and Mindray anesthesia machines that meet manufacturer specifications.



GE Aespire and Avance

Call 800-875-2355 for Market Price!



Drager Fabius GS



Mindray A3, A5

All machines come with a one year parts warranty.

Bell Medical, Inc. 314-772-5600 800-875-BELL (2355)

PATIENT MONITORS

Edan iM8 Patient Monitor



- ECG, RESP, NIBP, SPO2, 2-Temp, PR, Recorder
- 12.1" High resolution color TFT-LCD Display
- Arrhythmia, S-T Analysis, OxyCRG
- 120 Seconds Full-disclosure Waveforms Review
- 120 Hour Graphic and Tabular Trends
- Bi-directional Communications with Central
- Pacemaker detection
- Customized alarm setting
- SP10 Accuracy Validated NIBP
- Built-in rechargeable Li-ion battery
- Nurse call, VGA Output
- Suitable for Adult, Pediatric and neonatal patients

2 YEAR WARRANTY

Additional Configurations Available

iM8: 3/5 Lead ECG, RESP, NIBP, Edan SpO2, RESP, 2-Temp and Recorder	\$ 2,995
iM8: Above configuration with EtCO2	\$ 4,290
iM80: Above with, 4-IBP, EtCO2 and Agent Analysis	\$ 7,375

Edan MicroCap 9 Capnograph/Oximetry Monitor & Vital Signs Monitor



B203600 MicroCap 9 Capnograph/Oximeter Monitor	\$2,436
B203610 Watertrap for MicroCap 9, 10/pack	\$120
M3 Standard with SpO2 and NIBP	\$1,995
M3 Standard with SpO2, NIBP and Ear Temperature	\$2,495
M3 Standard with SpO2, NIBP and Covidian Oral Temperature	\$2,895

MINDRAY SURGICAL TABLES



- Easiest table to move with eight wheels on four casters
- Superior table height adjustment from 23" to 43"
- Two-year warranty, leader in industry
- Supports up to 1,000 lbs. static lift and 550 lbs. at full slide
- Slide top ensuring easy access with C-Arm
- Best value at 25% savings
- Bell Medical installation and service support nationwide

Call for information and free onsite demonstration or trial!

NEEDLES: REGIONAL ANESTHESIA

Gertie Marx Regional Anesthesia Needles

- Conical point minimizes PDPH
- Rounded edges with sideport as small and as close to the tip as possible minimizes “failed blocks”
- Thin wall needle
- Crystal clear hub
- Raised sideport indicator

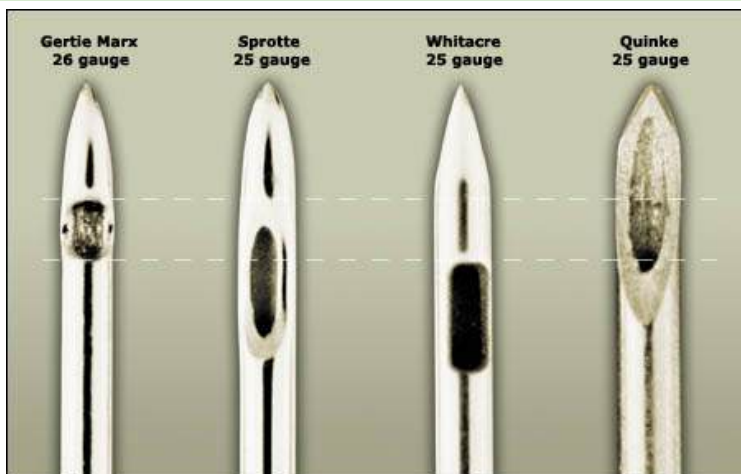

22 Gauge Needles with Introducer

B160040	50mm (2")	\$123.00 10/Box
B160041	70mm (2¾")	\$123.00 10/Box
B160001	90mm (3½")	\$123.00 10/Box
B160003	124mm (5")	\$147.00 10/Box
B160016	Spinal, 150mm (6")	\$162.00 10/Box
B160042	Spinal, 190mm (7½")	\$211.00 10/Box

24 Gauge Needles with Introducer

B160017	50mm (2")	\$123.00 10/Box
B160005	90mm (3¼")	\$123.00 10/Box
B160007	101mm (4")	\$123.00 10/Box
B160009	124mm (5")	\$147.00 10/Box
B160018	150mm (6")	\$162.00 10/Box

25 Gauge Needles with Introducer

B160019	50mm (2")	\$123.00 10/Box
B160021	90mm (3¼")	\$123.00 10/Box
B160043	101mm (4")	\$123.00 10/Box
B160023	124mm (5")	\$147.00 10/Box
B160024	150mm (6")	\$162.00 10/Box
B160026	160mm (6½")	\$162.00 10/Box
B160044	190mm (7½")	\$211.00 10/Box
B160045	215mm (8½")	\$254.00 10/Box

26 Gauge Needles with Introducer

B160047	50mm (2")	\$123.00 10/Box
B160011	90mm (3¼")	\$123.00 10/Box
B160013	101mm (4")	\$123.00 10/Box
B160015	124mm (5")	\$147.00 10/Box

27 Gauge Needles with Introducer

B160046	50mm (2")	\$123.00 10/Box
B160028	90mm (3¼")	\$123.00 10/Box
B160037	101mm (4")	\$123.00 10/Box
B160030	124mm (5")	\$147.00 10/Box
B160038	150mm (6")	\$162.00 10/Box
B160039	160mm (6½")	\$162.00 10/Box

LONG NEEDLE OPTIONS FOR CSE



Gertie Marx Combined Spinal with Epidural Needle

B160036	27G x 124MM Spinal Needle w/ 17G X 3½" Epidural Needle	10/box	\$254.00
B160033	26G x 124MM Spinal Needle w/ 17G X 3½" Epidural Needle	10/box	\$254.00
B160031	25G x 160MM Spinal Needle w/ 17G X 3½" Epidural Needle	10/box	\$280.00
B160034	27G x 160MM Spinal Needle w/ 17G X 5" Epidural Needle	10/box	\$280.00
B160032	25G x 190MM Spinal Needle w/ 17G X 6" Epidural Needle	10/box	\$280.00
B160035	25G x 215MM Spinal Needle w/ 17G X 7" Epidural Needle	10/box	\$334.00

NEEDLES

EchoBlock™ Echogenic Non-Insulated Needles



For Ultrasound Guided Regional Anesthesia (for those no longer using nerve stimulators)

- See the target & structures to avoid - for better accuracy and reduced needle sticks
- Faster, more accurate needle placement saves time in the Operating Room

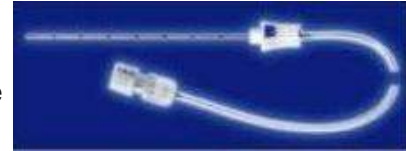

Fixed injection tube cannot be misplaced and will not leak.

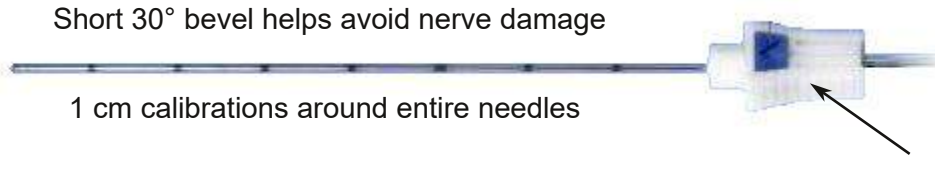

Short 30° bevel helps avoid nerve damage

1 cm calibrations around entire needles

BLUE BEVEL INDICATOR
verifies bevel position

B160502	21G x 2" (50mm)	25/box	\$287.50
B160503	21G x 3 1/8" (80mm)	25/box	\$287.50
B160504	21G x 4" (100mm)	25/box	\$320.00
B160506	21G x 6" (150mm)	25/box	\$356.00

Patented Corner Cube Reflectors (CCR™) Provide multi-angled surfaces for maximum reflection even at steep angles.

- See the needle and see the nerve
- Watch the anesthetic encircle the nerve under ultrasound



EchoStim™ Echogenic Insulated Needles

For Ultrasound Guided Regional Anesthesia (for those using nerve stimulators in conjunction with ultrasound)

- See the target & structures to avoid - for better accuracy and reduced needle sticks
- Faster, more accurate needle placement saves time in the Operating Room

B16052225	21G x 2" (50mm)	25/box	\$383.00
B16052325	21G x 3 1/8" (80mm)	25/box	\$383.00
B16052425	21G x 4" (100mm)	25/box	\$421.00
B16052625	21G x 6" (150mm)	25/box	\$421.00

Includes injection tube and standard plug that fits most stimulators.

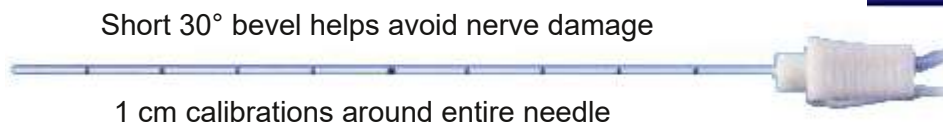
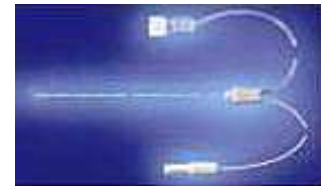

Short 30° bevel helps avoid nerve damage

1 cm calibrations around entire needle

QUANTITATIVE TOF MONITORING

STIMPOD 450X+ AMG/EMG QTOF Monitor, Nerve Locator and Stimulator

Quantitative TOF AMG and EMG Monitor and Nerve Locator w/NEW color touch screen display!

The STIMPOD NMS450X+ Nerve Stimulator includes EMG and 3D AMG technology with the simple change of a cable. The new Stimpod 450X+ offers a larger touch screen color display, rechargeable battery, trends, waveform information and easier operation. Quantitative Train-of-Four monitoring is endorsed by APSF and ASA Guidelines recommendation!

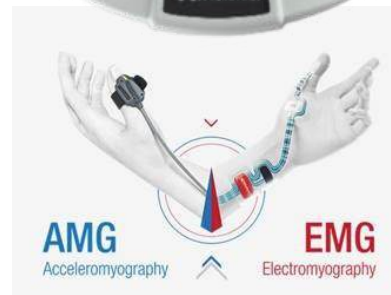

Documented QTOF success in recent study:

- Pulmonary complications reduced by 42%
- PACU time reduced by 7%
- Sugammadex dosage decreased by an average of 14%
- 7% increase in patients needing no reversal

Simple

- One-Touch NMT Monitoring
- Electrode Placement Verification
- Quick Setup & No Calibration needed
- Handheld with IV pole option
- Data Connectivity

Economical

- Reusable AMG Sensor or disposable EMG electrode array
- AMG uses standard ECG electrodes saving up to \$176,000/10,000 surgeries
- Quantitative NMT Monitoring reduces incidence of residual paralysis
- QTOF Increases OR and PACU throughput and lowers drug usage

Proven

- Proven to identify residual paralysis, FDA Approved
- Xavant has pioneered quantitative monitoring technology since 1998
- Trusted by anesthesiologists in over 40 countries

New features and capabilities:

Larger color touch screen display, rechargeable battery, trends and waveforms, Auto SMC One-Touch NMT, 40 hour battery & Auto Repeat TOF

Current Range

Nerve Locating: 0.0 – 5.0mA
Nerve Mapping: 0 – 20mA
NMBA Monitoring: 0 – 80mA

Stimulating Modes:

Train-of-Four (TOF)
Double Burst (DB)
Post-Tetanic-Count (PTC)
Tetanus (TET) 50Hz & 100Hz
Twitch (1Hz, 2Hz, 5Hz), DEP

B170450AE+ NMS450X+ AMG & EMG Nerve Stimulator Kit

\$2,374

STIMPOD NMS450X+, AMG (3.0m) and EMG (3.5m) QTOF Cables, Case, Two Year Warranty, 6 month on cables.

Order Online: www.BellMedical.com customerservice@BellMedical.com

QUANTITATIVE TOF MONITORING

XAVANT STIMPOD Nerve Stimulator Accessories



Battery Recharger and Replacement Batteries



X-Link EMR and Stimpod 450X+



AMG Reusable 3D Sensor



IV Pole Basket



Stimpod Nerve Locating/Mapping Probe Cable

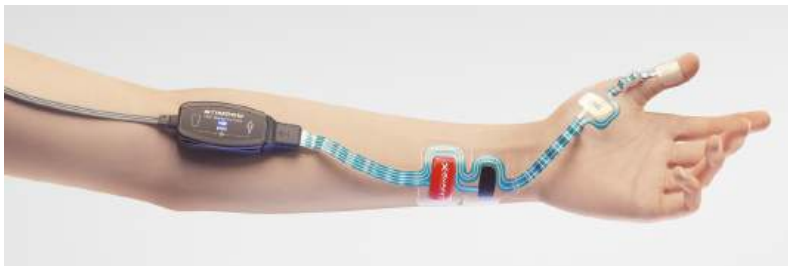

EMG Sensor and Cable



Stimpod Infinity IV Pole Mount

B170451	STIMPOD Adjustable Infinity IV Pole Mount	\$190 ea
B130120	IV Pole Mounted Basket	\$98 ea
B170465	NMBA AMG Cable w/Accelerometer (3.0m)	\$384 ea
B170445	EMG NMBA Cable, 11.5'	\$384 ea
B170453	Large EMG Electrode	\$440 20/bx
B170469S	Small EMG Electrode	\$440 20/bx
B170463	Accelerometer Straps, 3" 5/pack	\$71 5/pk
B170463L	Accelerometer Straps, Long, 5" 5/pack	\$71 5/pk
B170485	Stimpod X-LINK EMR Communications Module	\$895.00 ea
B170472	Stimpod Communications Cable, RS232 to Philips Interface	\$470.00 ea
B170475	Stimpod Software Download Cable, USB Interface	\$470.00 ea
B170461	Stimpod Nerve Locating/Mapping Probe Cable	\$200.00 ea
B170482	STIMPOD 450X+ Rechargeable LI-Ion Battery	\$27.70 ea
B170484	STIMPOD 450X+ External Battery Charger	\$56.00 ea

NERVE BLOCK POSITIONING DEVICE

Tereboot Supine Nerve Block Positioning Device

“No more turning patients prone or lateral to perform ultrasound guided sciatic nerve blocks at the popliteal fossa. No more stacking blankets or pillows just to achieve suboptimal, unstable and uncomfortable leg elevation and positioning.”

The Tereboot is a portable and adjustable lower extremity positioning device that you place directly onto your patient's bed for supine positioned ultrasound guided popliteal fossa blocks, adductor canal blocks, saphenous blocks, ankle blocks and nerve stimulation technique popliteal fossa blocks. Reusable pad is made with medical grade vinyl that can be disinfected with standard wipes.



The Tereboot

- No additional space necessary - placed directly on patient's bed
- Height adjustable for patient comfort and to create ample space for the U/S probe in the posterior popliteal fossa
- Adjustable to compensate for leg rotation
- Leg stability for procedure safety and sterility
- Reusable vinyl cushion
- 5-year warranty

Supine Position

- Patient comfort and convenience
- Airway monitoring and intervention with sedation
- Procedure efficiency

Portable

- Weighs only 11 lbs
- Footprint: 11.5"x12"

Sturdy and Durable

- All metal construction - black matte finish

Adjustable

- Height
- Tilt

B180350K Tereboot New Customer Kit
(1 Tereboot Frame, Vinyl Pad)

\$995

B180351 Tereboot Replacement Pad, Vinyl, Reusable

\$175

**Never
Flip
Again!**

NERVE STIMULATORS

SunStim Nerve Stimulator and Accessories

New SunStim™ Pro Peripheral Nerve Stimulator

- Easy to read illuminated digital screen functionality
- Ergonomic compact shape fits comfortably in hand
- Optional removable silicone wrap enhances grip, protects device (sold separately)
- Stimulator output current is fully adjustable from 0-70 mA
- Double burst: 2 60-ms bursts of 50 Hz separated by .75 s
- Twitch: 1 pulse per second
- Tetanus: 50 Hz (50 pulses/s) or 100 Hz (100 pulses/s)
- Built-in train of four: 4 pulses in a period of 2 seconds
- Stimulus pulse: square wave monophasic pulses (200 μs duration)
- Side switch to increase/decrease level of stimulation
- Standard battery: 9 volt alkaline
- Nerve stimulator includes battery, ball electrodes, 6' lead with clips (snap version sold separately)



B170104 \$530.00

**See page 67 for
Quantitative TOF**

SunStim™

- Stimulator output current is fully adjustable from 0-70 mA
- Stand-by position: no stimulus pulses are generated
- Twitch: 1 pulse per second
- Tetanus: 100 Hz (100 pulses/s)
- Built-in train of four: 4 pulses in a period of 2 seconds
- Battery indicator light flashes when battery needs to be replaced
- LED (green) battery light indicates that the unit is on, flashes on low battery
- LED (red) flashes with audible indicator sounds each time a stimulus pulse is generated
- Standard battery: 9 volt alkaline
- Nerve stimulator includes battery, ball electrodes, 6' lead with clips (snap version sold separately)



B170103 \$360.00

SunStim Plus™ includes all features of B170103 plus:

- Double burst: 2 60-ms bursts of 50 Hz separated by .75 sec
- Tetanus: 50 Hz (50 pulses/s) or 100 Hz (100 pulses/s)

B170101 \$395.00



SunStim Accessories and Replacement Parts

IV Pole Mount Bracket for SunStim and SunStim Plus	B170118	\$189.00
IV Pole Mount Bracket for SunStim Pro	B170114	\$226.00

Bipolar probe for all SunStims	B170110	\$43.50
--------------------------------	---------	---------

Replacement Extension Leads for all SunStims

Six foot Extension Leads with Alligator Clips:	B170116	\$65.00
Six foot Extension Leads with Snaps:	B170115	\$68.50

Silicone Pro Wrap for SunStim Pro only	B17012X (specify color)	\$44.00
Teal, Green, Orange, Red, Pink, Fuchsia, Purple, Blue, Gray		



OXYGEN SENSORS

Ohmeda One Year Oxygen Sensor

Ohmeda 5250 RGM, Excel Series, Module Series Hewlett Packard

B180104 \$120.00



Draeger Dual Cathode One Year Sensor

Draeger Narkomed, 6000, 8000, Evita 2, Evita 4

B180105 \$130.00



Ohmeda Two Year Extended Life Sensor

Ohmeda 5250 RGM, Excel Series, Module Series

B180102 \$175.00



Draeger Two Year Extended Life Sensor

Draeger Narkomed 2B, 2B, 3, 4

B180103 \$175.00



Ohmeda SmartVent Oxygen Sensor

Ohmeda SmartVent 7900, Aestiva

B180106 \$120.00

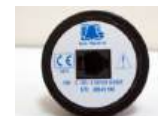

Anestar Oxygen Sensor

Datascope Anestar, Engstrom MIE, MiniOx I, II, III, Puritan Bennett 7820

B180110 \$90.00



Mindray Oxygen Sensor

Mindray A5 Anesthesia Machine

B180114 \$120.00



Penlon Oxygen Sensor

Penlon Anesthesia Machine

B180108 \$120.00



Hudson Oxygen Sensor

Hudson 5577, 6477, 5590 (replaces Hudson 5500)

B180111 \$90.00



Oxygen Analyzer Sensor

Replaces Maxtec OM-25AE, OM-25ME

B180112 \$90.00



Criticare Oxygen Sensor

Replaces Criticare 644, Air Shields, Puritan Bennett 840 Vent, Siemens 300 Series, 900 Series

B180113 \$120.00



POSITIONING PADS

QView: Prone Pillow, Low Cost ProneView Cushion Substitute



QView Prone Pillow Advantages

- Low-cost cushion compatible with current ProneView Helmet System
- Hypoallergenic layer of 3M biocompatible material for patients with sensitive skin
- Clear view access to patient's mouth, nose, eyes with ET tube support and mirror
- Comfortable and supportive of patient's head and neck in contoured pillow cradle
- Single patient use item controls infections and eliminates reprocessing cost
- Lightweight, soft and latex free polyurethane foam with acrylic mirror
- Packaged clean non-sterile, latex free
- Customer review: "QView has no odor whereas Proneview has a fishy smell."

QView Prone Pillow Solutions with 3M hypoallergenic facial coating

B180511	QView, Freestanding w/mirror, LWH: 30.5 X 24.5 X 12cm	\$192 8/case
B180512*	QView-P, used with ProneView Helmet, 30.5 X 24.5 X 12cm*	\$192 8/case

*Exact fit substitute for Mizuho ProneView #D28505CE cushion at guaranteed savings!

PI POSITONING PADS

Pi Bariatric Intubation Positioning Pillow and Ramp

Pi Bariatric Pillow and Ramp aid in mask ventilation, allow for a quality laryngeal view and provide easier intubation while maintaining patient comfort and oxygen saturation.



Figure 3 Patient on OR bed without Pi's Obesity Pillow, the mass of chest is above the plane of upper airway.

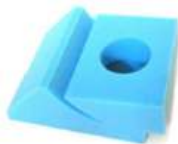

Figure 4 Patient on OR bed with Pi's Obesity Pillow, the mass of chest is moved away from the plane of upper airway.

- Maintains the head and neck in extension for easier first pass intubations.
- Naturally positions airway making the laryngeal inlet easily visible.
- Reduces laryngoscope force needed to lift a patient's head, chin and neck.
- Provides proper airway positioning reducing the chance of damaging airway tissue.
- Aid during post-surgery transport and in PACU to aid in patient breathing & comfort.
- Vacuum packed reducing storage space and shipping cost
- Cost savings with Pi having two products in one with ramp and positioning pillow

B180501	Disposable Bariatric Pillow and Ramp 24" x 18" x 8"	\$239.00	6/case
B180501R	Reusable Bariatric Pillow and Ramp 24" x 18" x 8"	\$785.00	Each
B180507R	Bariatric Arm Rest, 1 set 22" x 5.5" x 7"	\$280.00	2/case
B180500	Disposable cover for the B180501R Pillow	\$119.40	12/case

Pi Intubation Positioning Pillow



B180504	Disposable Medium Adult Pillow 10.5" x 9" x 4"	\$57.00	12/case
B180504R	Reusable Medium Adult Pillow 10.5" x 9" x 4"	\$475.00	Each

PULSE OXIMETRY

Adult Finger Pulse Oximeter

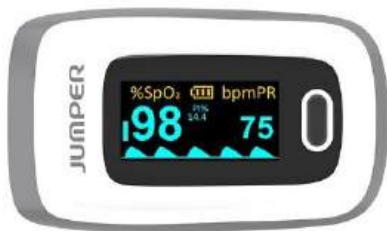

Features:

- Color OLED display
- Audio alarms
- Display SpO2, Pulse Rate, Pulse bar
- Blood perfusion index (PI) as low as 0.2%
- 6 display modes for easy reading from all sides.
- Battery-low indicator
- 2 AAA alkaline batteries
- Accommodates finger sizes from pediatric to adult
- Carrying pouch
- 1 year limited warranty

Child Finger Pulse Oximeter Plus

LED only display.

B400303

1-5 Price: \$80.00

6-24 Price: \$75.00

25+ Price: \$69.00



B400304 each \$123.00

B400303P Carrying Pouch, Orange \$3.00

Handheld Pulse Oximeter



The EDAN SpO2 technology has the equivalent performance as the industry leaders'. Its pocket-size design makes it extremely suitable for spot-checks and ambulatories.

- Compact & lightweight
- Battery charger stand design (optional)
- LCD display of real-time measurements
- Real-time clock
- Pitch tone
- Advanced SpO2 high accuracy performance
- Plethysmogram display
- Trend table and trend graphs
- Large storage capacity
- Data management via PatientCare Viewer software(optional)

B400301 \$459.00

PULMODYNE BITRAC™ NIV MASKS

Pulmodyne's BiTrac Select series of noninvasive ventilation masks now has a variety of interchangeable elbows which creates multiple uses for just one mask. Along with interchangeable elbows, a selection of cushion shapes are provided to help find the right fit for patients.

BiTrac Select™ NIV Full Face Mask, Interchangeable Anti-Asphyxia Elbow 22mm Female, OmniClip™, Silicone Forehead Pad and Head Strap

Classic Cushion (PD)™

B101004	Adult Extra Large	\$240.00 10/case
B101003	Adult Large	\$240.00 10/case
B101002	Adult Medium	\$240.00 10/case
B101001	Adult Small	\$240.00 10/case

Improved OmniClip™



BiTrac Select™ NIV Full Face Mask, Fixed Anti-Asphyxia Elbow 22mm Female, OmniClip™, Silicone Forehead Pad

B101024	Adult Extra Large	\$235.70 10/case
B101023	Adult Large	\$235.70 10/case
B101022	Adult Medium	\$235.70 10/case
B101021	Adult Small	\$235.70 10/case

BiTrac Select™ NIV Nasal Mask with Fixed Standard

Elbow 22mm Female and Silicone Forehead Pad Classic Cushion (PD)™

B101036	Adult Large	\$214.00 10/case
B101035	Adult Medium	\$214.00 10/case
B101034	Adult Medium/Small	\$214.00 10/case
B101033	Adult Small	\$214.00 10/case

Call for Premiere Contract Pricing

MAX SHIELD

BiTrac MaxShield Select™ with Interchangeable Anti-Asphyxia Elbow with Leak 22mm Female, and MaxShield Head Strap

B101105	Extra Large	\$385.70 10/case
B101102	Adult	\$385.70 10/case
B101104	Small Adult	\$385.70 10/case
B101109	Pediatric XS	\$750.00 10/case
B101108	Pediatric XXS	\$750.00 10/case

BiTrac MaxShield Select allows for unobstructive view, minimizing claustrophobia



BiTrac MaxShield™ with Fixed Anti-Asphyxia Elbow with Leak 22mm Female, and Head Strap

B101057	Extra Large	\$373.60 10/case
B101052	Adult	\$373.60 10/case
B101054	Small Adult	\$373.60 10/case

Interchangeable Elbow Options for BiTrac MaxShield Select™

B031009	Standard (SE) Elbow, for dual limb circuit	\$60.00	10/case
B031008	Anti-Asphyxia (EE) Elbow, for single limb circuit	\$60.00	10/case
B031007	Standard (SE) Bronchoscopy Elbow, for dual limb	\$60.00	10/case
B031006	Anti-Asphyxia (EE) Bronchoscopy Elbow, single limb c	\$60.00	10/case

Call for additional elbow options.

Circuits for Bilevel/CPAP Available, call for options.

Order Online: www.BellMedical.com customerservice@BellMedical.com

STETHOSCOPES / TEMPERATURE MONITORING

Chest Pieces

Adult, Large, Wenger™ Weighted Chest Piece

B190046 \$27.00

Pediatric, Small, Wenger™ Weighted Chest Piece

B190045 \$26.00



Lightweight Chest Pieces

Infant Lightweight Chest Piece, 1 1/8"

Diameter **B190048 \$25.50**

Newborn Lightweight Chest Piece, 7/8" Diameter

B190047 \$22.50

Double Stick™ Adhesive Discs

For chest pieces and electrode attachments.

B190050 100/roll \$29.00



SoftEar™ Disposable Monascope

The acoustic earpiece enhances transmission of sound by conforming to the ear canal. The SoftEar™ earpiece is more comfortable than the hard plastic earpiece. 4' tubing length.

B190100 25/Box \$108.00



Disposable Esophageal Stethoscopes

Heart and breath sounds are easily discerned due to the excellent acoustics inherent in the configuration of the stethoscope. The soft cuff and compliant PVC shaft are designed to minimize trauma during intubation.

Esophageal Stethoscope w/400 Series Temperature

9 French B190240 50/Box \$240.00

12 French B190241 50/Box \$240.00

18 French B190242 50/Box \$240.00

24 French B190243 50/Box \$308.00

Esophageal Stethoscope without Temperature

9 French B190203 50/Box \$180.00

12 French B190200 50/Box \$180.00

18 French B190201 50/Box \$180.00

24 French B190202 50/Box \$180.00



Esophageal Stethoscope Temperature Cables, Reusable



400 Series, Stereo Jack Plug

B190503 \$42.00

Philips / HP Plug

B190505 \$42.00



General Purpose Temperature Probe, Disposable

9 French, 400 Series B190250 50/Box \$193.50

12 French, 400 Series B190251 50/Box \$193.50

Skin Temperature Probe, Disposable

Adult, 400 Series

B190259 50/Box \$185.00

Ear Tympanic Temperature Probe, Disp

Adult, 400 Series

B190257 50/Box \$210.00

Bell Medical, Inc. 314-772-5600 800-875-BELL (2355)

STYLETS

Rigid Stylet - Reusable, For 6.0mm tubes and larger



B091996 Blue Handle \$24.50 each



B091902 Orange Handle \$52.00 each

Rigid Stylet, Disposable 10/box

B190560	J-Wand with O2 Port, Sterile	\$150.00
B190561	J-Wand with O2 Port, Non-Sterile	\$150.00
B190562	Rtech, Non-Sterile	\$78.50
B190563	Rtech, Sterile	\$88.50



Stylet (Bougie), Disposable

15 French for 6.0 - 11.0mm tubes, Angled Tip, Orange
(Clean and ready for patient use)

B091911 10/box \$72.00



15 French for 6.0 - 11.0mm tubes, Angled Tip, Blue, Sterile

B190525 (straight package) 10/box \$122.00

B190524 Bougie-To-Go 10/box \$122.00



New package option:
"Bougie-To-Go"



10 French Pediatric, Angled Tip, Blue, Sterile

B190520 10/box \$130.00



PVC Stylet

Malleable aluminum intubation stylet sealed in a PVC sheath. Latex free, sterile, single use.

10" x 6 French	B190331	\$107.00 20/box
11.5" x 10 French	B190332	\$107.00 20/box
12.5" x 14 French	B190333	\$107.00 20/box



Stylet (Bougie) with Oxygen Port, Disposable

The disposable endotracheal tube introducers and guides are sterile and individually packaged.

• Removable hose barb & 15mm Male fitting • Coudé Tip with two eyes • Length 70cm

15 French for 6.0 - 11.0mm tubes, Angled Tip, 15mm Hose Barb

B190527 \$140.00/10



• Removable 15mm O2 Connector/Luer Lock • Coudé Tip, two Eyes • Length 65cm • Depth Marked

15 French for 6.0 - 11.0mm tubes, Angled Tip, O2 Connector

B190540 \$138.00/5



• Removable 15mm O2 Connector/Luer Lock • Coudé Tip with three eyes

8 French, 40cm for ET tubes \geq 3.5, Angled Tip, O2 Connector

B190547 \$192.00/5

11 French, 65cm for ET tubes \geq 5.0, Angled Tip, O2 Connector

B190548 \$192.00/5

15 French, 65cm for ET tubes \geq 6.0, Angled Tip, O2 Connector

B190549 \$192.00/5



SYRINGE PUMP

OR - INFUSOR ABC Pump 4100

Syringe Infusion Pump for Anesthesia/OR/ICU and NICU

The ABC OR – Infusor is easy to use; allowing users to customize the delivery modes to each patient. The pump comes with fast and easy front syringe and plunger loading. It comes with a cordless power pack that lasts up to 12 hours at 5ml/hr. The warranty is a full one year with free software upgrades. Our new software adds a one button continuous rapid bolus feature!



- Accommodates various syringe manufacturers with automatic size sensing: 1, 3, 5, 10, 20, 30, 60 and 140 ml syringes
- Unique labeling area used to indicate infusion information
- Full alarm capabilities - LED & LCD alerts & audio alarms
- Integrated carrying handle with optional pole mount
- Multiple sensors to monitor delivery accuracy
- Large graphic LCD display for easy viewing
- Simple operation – Easy User customization
Multiple delivery modes (Body-Weight, Mass, Bolus, Continuous, Volume over Time); Adjustable flow rate ranges, changes w/o interrupting flow; Accuracy +/- 3%
- New software offers one button bolus feature that delivers rapid bolus rate of 1,500 mL/hr
- Storage for 90 user defined programmable settings
- Syringe light delineates infusion status from afar
- AC/Battery operated with removable battery pack
- RS232 Interface capabilities

B400230	Syringe Pump	\$3,645
B400231	Rotational Pole Clamp	\$165
B400232	Clone Cable	\$170

One year warranty with free software upgrades!

Bell Medical, Inc. 314-772-5600 800-875-BELL (2355)

TEMPERATURE

CliniTemp™ Moving Line Temperature Indicators

CliniTemp™ moving line temperature indicators are non-invasive, easy to use, highly reliable, and provide precise readings that have been well documented over the years.

CliniTemp™ moving line temperature indicators measure surface temperature and give you a core-adjusted reading on a continuous scale on both Centigrade (29° - 41°C) and Fahrenheit (84° - 106°F).

- Accurate to +/- .5°F, 3°C
- Core-adjusted with 3.5°F, 2°C offset



B192000	100/box	\$172.00
B192001	50/box	\$88.00



Esophageal Stethoscope Temperature Cables, Reusable



400 Series, Stereo Jack Plug

B190503 **\$42.00**

Philips / HP Plug

B190505 **\$42.00**



General Purpose Temperature Probe, Disposable

9 French, 400 Series	B190250	50/Box	\$193.50
12 French, 400 Series	B190251	50/Box	\$193.50

Disposable Esophageal Stethoscopes

Heart and breath sounds are easily discerned due to the excellent acoustics inherent in the configuration of the stethoscope. The soft cuff and compliant PVC shaft are designed to minimize trauma during intubation.

Esophageal Stethoscope w/400 Series Temperature

9 French	B190240	50/Box	\$240.00
12 French	B190241	50/Box	\$240.00
18 French	B190242	50/Box	\$240.00
24 French	B190243	50/Box	\$308.00

Esophageal Stethoscope without Temperature

9 French	B190203	50/Box	\$180.00
12 French	B190200	50/Box	\$180.00
18 French	B190201	50/Box	\$180.00
24 French	B190202	50/Box	\$180.00

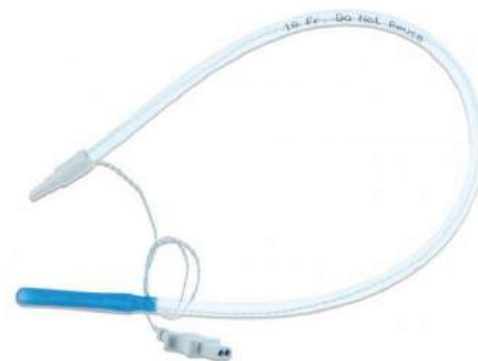

Skin Temperature Probe, Disposable

400 Series **B190259** **50/Box** **\$185.00**

Ear Tympanic Temperature Probe, Disposable

400 Series **B190257** **50/Box** **\$210.00**

READY HEAT TEMPERATURE BLANKETS

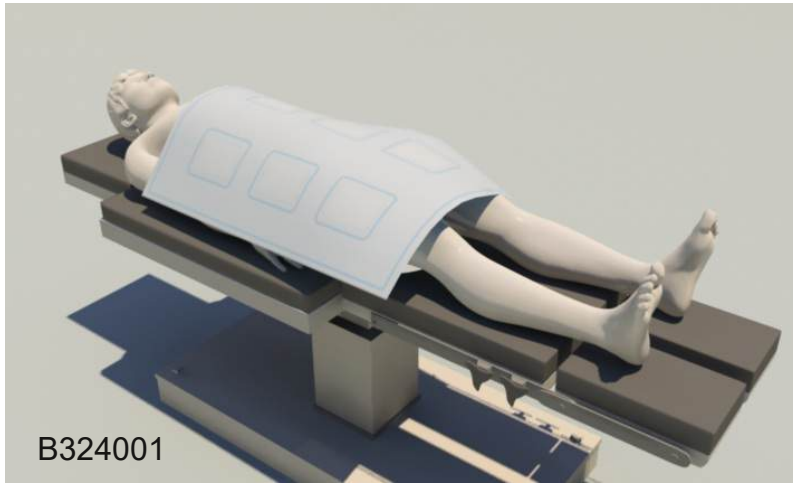

B324001

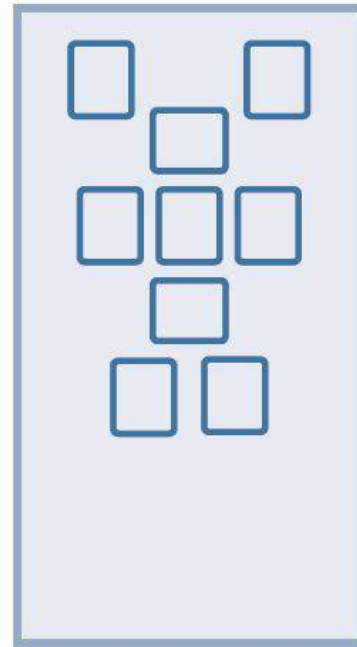

B324000

**Warmth without
forced air**

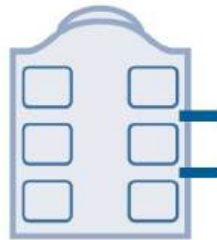

B324002

- Mobile patient warming that moves with the patient from pre-op, intra-op and post-op.
- Warms up automatically, no electricity needed, 38-40c in 10-15 minutes up to 10 hours.
- Cost effective way to prevent hypothermia, increasing patient comfort and an effective solution for infection control and reduced surgical site infections.
- Medical grade non-woven material, engineered thermal pads and proprietary high frequency welding constitute this fully-disposable patient warming solution.
- With a complete line of blankets, Ready-Heat can be used in the operating room, for patient rescue, transport and throughout the hospital for treating shock, trauma and hypothermia.
- Ready-Heat blankets have been US military medical protocol since 2006, as well as the choice of the US Air Force for patient transport.
- Five year shelf life and compact storage.

Patient Warming Blankets:

B324000	Adult Full Body, 34"x60"	\$256	10/box
B324001	Adult Half Body, Upper or Lower Body, 24"x34"	\$357	20/box
B324002	Infant Cocoon, 26"x26"	\$314	12/box

First Responder Warming Blankets:

B324003	Adult, 34"x48"	\$228	8/box
B324004	Adult Half Body, 34"x44"	\$236	12/box

Proudly made in the USA!

ULTRASOUND

Safersonic Sterile Ultrasound Probe Covers



Fits all major ultrasonic probe heads! Designed for nerve blocks. The ultrasound probe is fully covered by the sterile cover. Sterile procedures can start promptly! After procedure, remove the cover as shown, no residual glue remains! Reduces cleaning time, and improves turnover time for next procedure.

The patented adhesive keeps the cover and the probe head together without bubbles or wrinkles improving image quality.

B401530	Continuous Block Ultrasound Probe Cover, 120cm	50/box	\$430.00
B401534	Continuous Block Ultrasound Probe Cover w/Gel	50/box	\$535.00
B401539	Continuous Block, Narrow US Probe Cover w/Gel	50/box	\$535.00
B401531	Single Shot Ultrasound Probe Cover 28cm	50/box	\$330.00
B401536	Single Shot Ultrasound Probe Cover w/Gel, 28cm	50/box	\$425.00
B401533	Medium Ultrasound Probe Cover w/Gel, 50cm	50/box	\$506.00
B401538	Long Ultrasound Probe Cover w/Gel, 250cm	40/box	\$558.00



Watch a short video on
the Safarsonic
Ultrasound Probe
Covers



BELL MEDICAL SURGICAL DRAPE CLIPS



These high tension surgical drape clips are ideal for supporting sterile drapes to IV poles in the operating room. Our "drape clips" are designed specifically for anesthesia with high tension springs and grip teeth to hold sterile drapes to IV poles.

Order number: B000001

\$98.00 per box of 24

(\$4.08 each - a 30% savings)

Order number: B000002

\$5.85 each

Call **1-800-875-2355** to place an order or purchase online at
www.BellMedical.com



Back

Bell Medical "Sleep with the Best" T-shirt

B000010	Small	\$12.00
B000011	Medium	\$12.00
B000012	Large	\$12.00
B000013	X-Large	\$12.00
B000014	2X-Large	\$14.00
B000015	3X-Large	\$14.00



Front



Bell Medical
INC.



1728 Macklind Avenue
St. Louis, MO 63110

EyePro Eyelid Occlusion Dressing and NoPress Eye Shield



See page 29

EyePro:

- Easy to apply and remove
- Sterile dressing seals the eye
- Clear window for eye monitoring

NoPress:

- Eliminates pressure on eyes
- Clear view of eyes
- Easy to apply and remove



Call for free samples!

BellMedical.com
800-875-BELL (2355)